



Free Downloads of Build Instructions,
Assembly Booklets & How To Guides

BuildInstructions.com

WARHAMMER

40,000

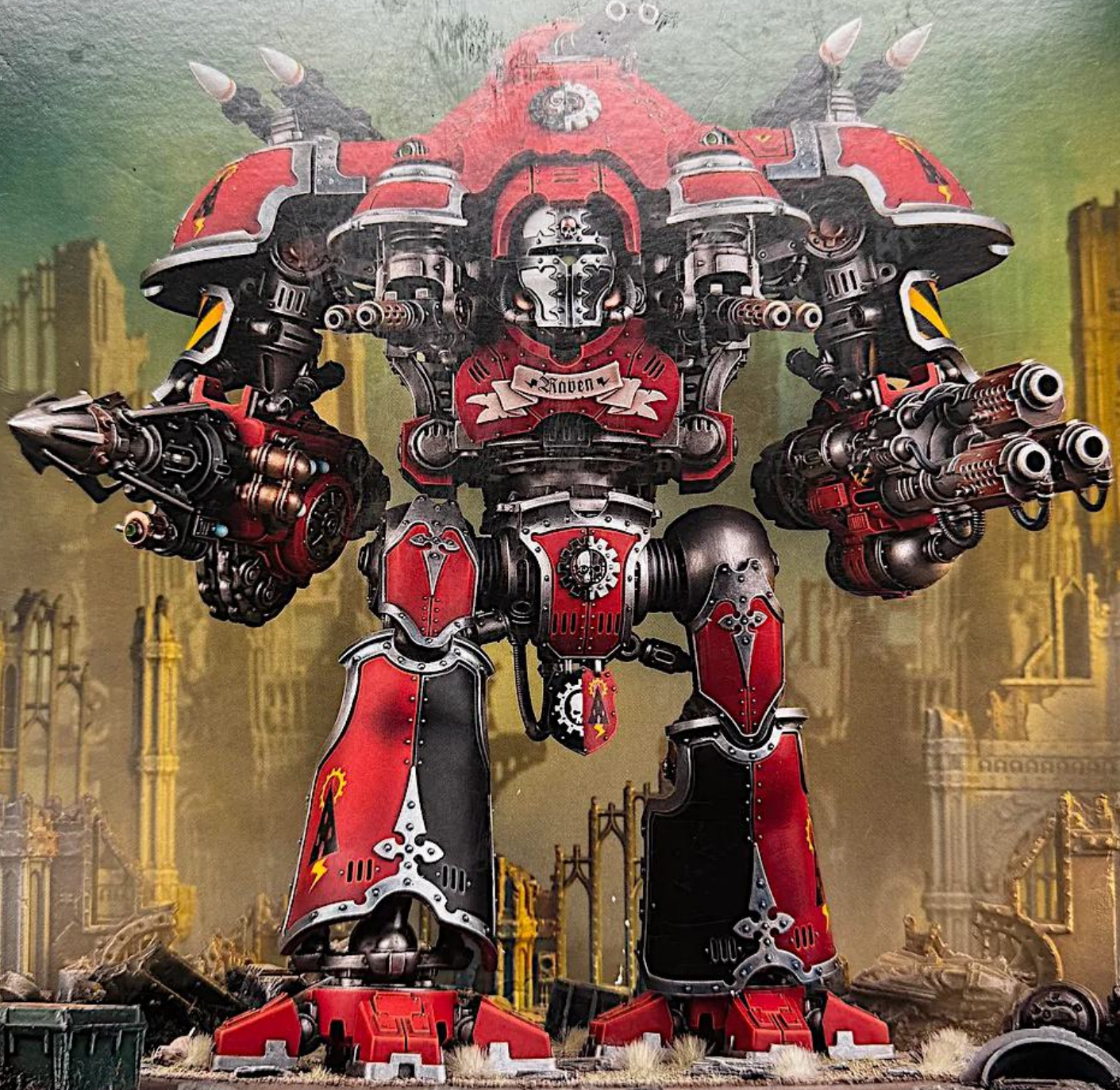

IMPERIAL KNIGHTS
KNIGHT DOMINUS

1 CITADEL®
MINIATURE





ENG BEFORE ASSEMBLING YOUR MINIATURES, PLEASE READ THROUGH THE INSTRUCTIONS IN THIS BOOKLET CAREFULLY. A pair of plastic cutters is required to remove the plastic components in this kit from their frame. We advise using a mouldline scraping tool to clean up the parts. To assemble your model you will need plastic glue. Games Workshop sells Citadel Fine Detail Cutters, Citadel Mouldline Remover and Citadel Plastic Glue, but does not recommend these products for use by children under the age of 16 without adult supervision.

FRE AVANT D'ASSEMBLER VOS FIGURINES, VEUILLEZ LIRE ATTENTIVEMENT LES INSTRUCTIONS DE CE LIVRET. Une pince coupante est requise pour détacher chaque élément de sa grappe. Nous vous recommandons l'utilisation d'un grattoir pour ébarber les éléments. Pour l'assemblage, vous aurez également besoin de colle plastique. Games Workshop commercialise les Pinces de Précision Citadel, l'Ébarboir Citadel et la Colle Plastique Citadel, mais n'en recommande pas l'utilisation pour des enfants de moins de 16 ans sans la supervision d'un adulte.

SPA POR FAVOR, LEE CUIDADOSAMENTE ESTE LIBRETO DE INSTRUCCIONES ANTES DE EMPEZAR A MONTAR LAS MINIATURAS. Te harán falta unas tenazas para plástico a fin de separar las piezas de la matriz. También aconsejamos una herramienta para rebabas a fin de limpiar cada pieza. Para montar la miniatura necesitarás pegamento para plástico. Games Workshop vende Tenazas Citadel, Herramientas para rebabas Citadel y Pegamento para plástico Citadel, pero no recomienda estos productos menores de 16 años sin la supervisión de un adulto.

















































GER VOR DEM ZUSAMMENBAU DER MINIATUREN BITTE DIE ANWEISUNGEN IN DIESER ANLEITUNG AUFMERKSAM DURCHLESEN. Du benötigst einen Kunststoffseitenschneider, um die Kunststoffbauteile aus dem Gussrahmen herauszutrennen, und Kunststoffkleber, um die Miniatur zusammenzubauen. Außerdem empfehlen wir, die Bauteile vorher mit einem Gussratentferner zu säubern. Games Workshop bietet Präzisions-Kunststoffseitenschneider von Citadel sowie Citadel-Kunststoffkleber an, empfiehlt aber, dass Kinder unter 16 Jahren diese nur unter Aufsicht eines Erwachsenen benutzen.

ITA PRIMA DI ASSEMBLARE LE TUE MINIATURE LEGGI ATTENTAMENTE TUTTE LE ISTRUZIONI DI QUESTO LIBRETTO. Sono necessarie un paio di tronchesine per plastica per staccare i componenti dai loro sprue. Consigliamo di usare un attrezzo apposito per pulire i componenti. Per assemblare il modello avrai bisogno di colla per plastica. Games Workshop vende Tronchesine di precisione Citadel, Attrezzo per ripulire Citadel e Colla per plastica Citadel, ma non consiglia questi prodotti ad un pubblico minore di 16 anni senza la supervisione di un adulto.

JPN ミニチュアを組み立てる前に、この冊子の説明をよくお読みください。本キット内のフレームからプラスチックパーツを切り離すためには、ニッパーが必要です。パーツのモールドを平らにするには、専用ツールを使用をお勧めいたします。本キットの組み立てには、プラ用接着剤が必要です。ゲームズワークショップはシタデル・ニッパー、プラ用接着剤、シタデル・モールドラインリムーバーを販売しておりますが、16歳以下の子供が大人の監督なしにこれらの道具を使用されることをお勧めしません。

CHN 组装模型前请仔细阅读本手册中的说明。你需要一把模型剪将塑料部件从版板上剪下来。我们建议使用分模线刮刀来处理零件。组装时你还需要用到模型胶水。你从 Games Workshop 处购买到 Citadel Fine Detail Cutter 模型剪、Citadel Mouldline Remover 分模线刮刀和 Citadel Plastic Glue 模型胶，但 16 岁以下儿童不得在没有成年人监护的情况下使用这些产品。

EXPLANATION OF SYMBOLS | EXPLICATION DES SYMBOLES | EXPLICACIÓN DE SÍMBOLOS | ERLÄUTERUNG DER SYMBOLE | LEGENDA DEI SIMBOLI | アイコン解説 | 符号説明

-  • Special instruction - take care
-  • Instruction spéciale - faites attention
-  • Instrucciones especiales - presta atención
-  • Besondere Anweisung - bitte beachten
-  • Istruzioni speciali: prestare attenzione
-  • 特記事項 - 要注意
-  • 特别说明 - 小心
-  • Variant assembly
-  • Variante d'assemblage
-  • Variante de montaje
-  • Bauvariante
-  • Assemblaggio alternativo
-  • 組み立てバリエーション
-  • 多种组装方式
-  • Choice of parts
-  • Choix d'éléments
-  • Modelos de componentes
-  • Auswahl an Teilen
-  • Scelta di componenti
-  • パーツの選択
-  • 选择部件
-  • Paint before assembly
-  • Peindre avant assemblage
-  • Pintar antes del montaje
-  • Erst bemalen, dann zusammenbauen
-  • Dipinti prima dell'assemblaggio
-  • 組み立て前にペイントすること
-  • 组装前涂装
-  • Do not glue the components
-  • Ne pas coller les éléments
-  • No pegar los componentes
-  • Bitte die Teile nicht kleben
-  • Non incollare i componenti
-  • このパーツは接着不可
-  • 请勿粘接
-  • Stage complete
-  • Etape terminée
-  • Paso completado
-  • Schritt abgeschlossen
-  • Fase completa
-  • このステージの完成
-  • 完成
-  • Build this many
-  • Assembler cette quantité
-  • Monta esta cantidad.
-  • Angegebene Anzahl bauen
-  • Assemblane il numero indicato
-  • この数だけ組み立てること
-  • 重复步骤

CONTENTS | CONTENU | CONTENIDO | INHALT | CONTENUTO | コンテンツ | 内含板件

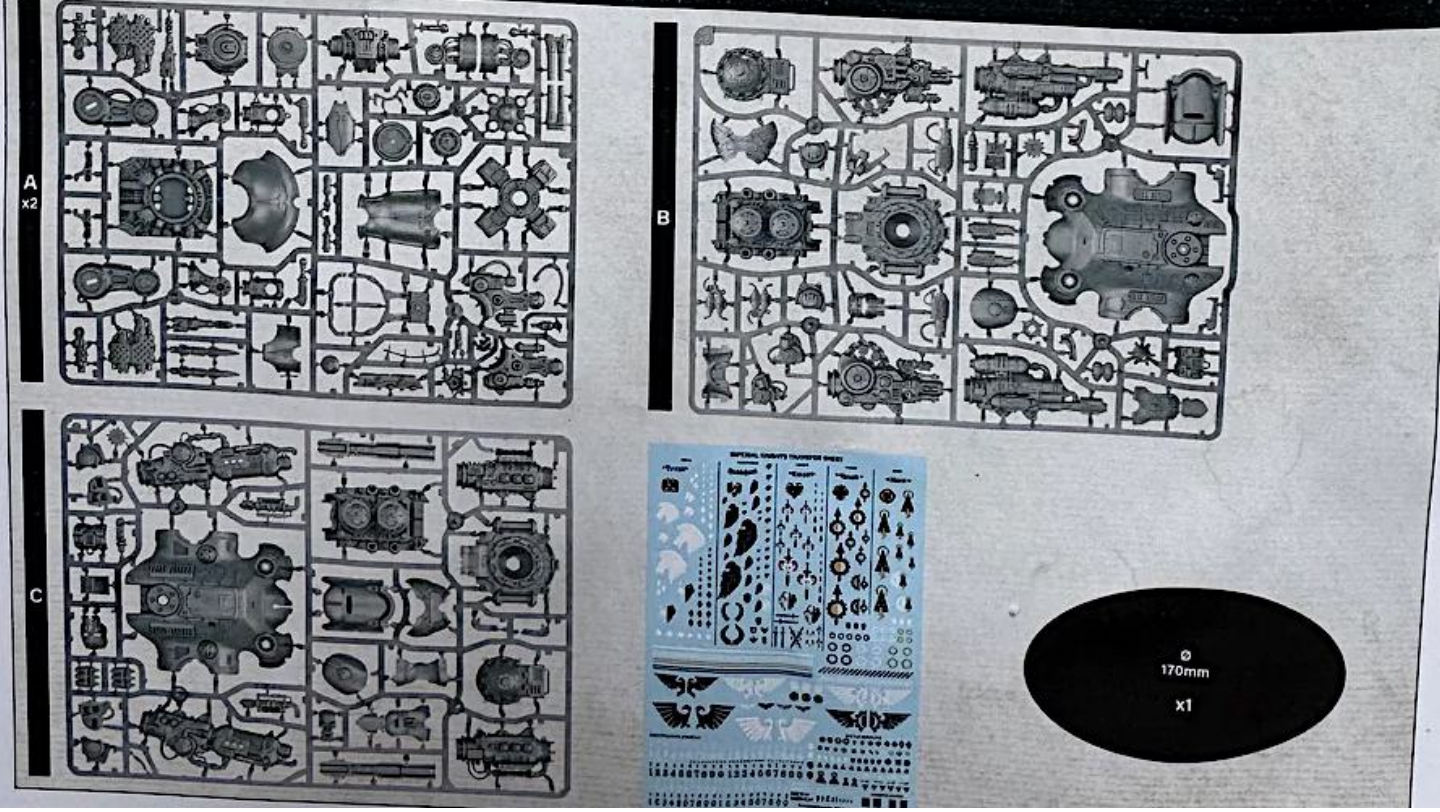

KNIGHT VALIANT

CHEVALIER VAILLANT | CABALLERO VALIENTE
BRESCHENRITTER | CAVALIERE VALIANT
ナイト・ヴァリアント | 英勇騎士

STEPS | ÉTAPES | PASOS | SCHRITTE
FASI | ステップ | 步骤

1 - 10

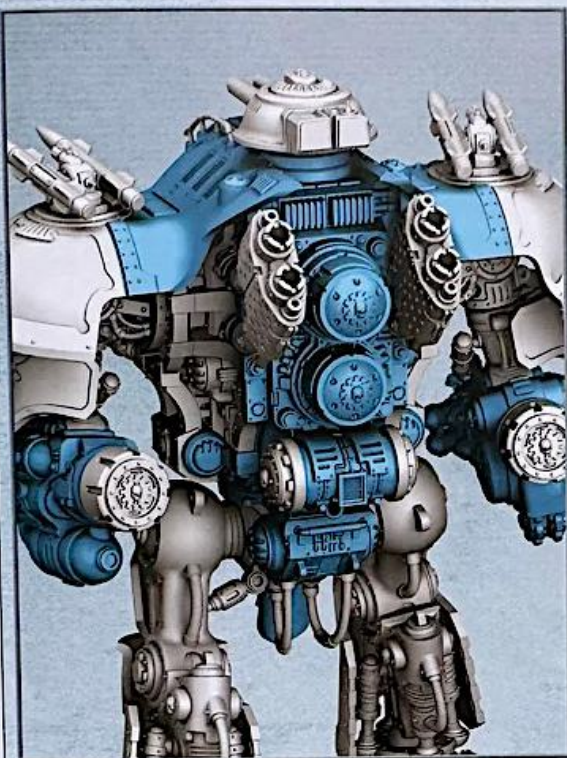

KNIGHT CASTELLAN

CHEVALIER CASTELLAN | CABALLERO CASTELLANO
KASTELLANRITTER | CAVALIERE CASTELLAN
ナイト・キャステラン | 堡主騎士

STEPS | ÉTAPES | PASOS | SCHRITTE
FASI | ステップ | 步骤

11 - 20



1

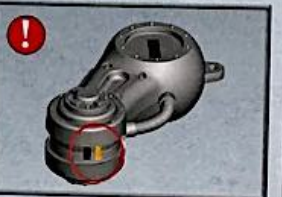
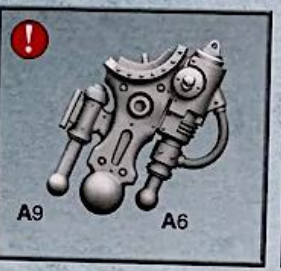
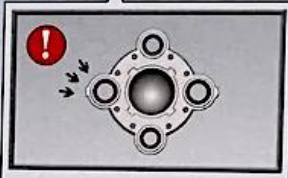
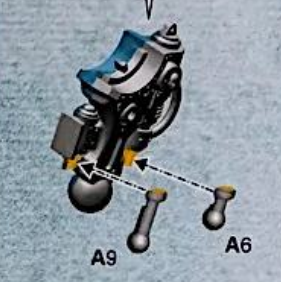
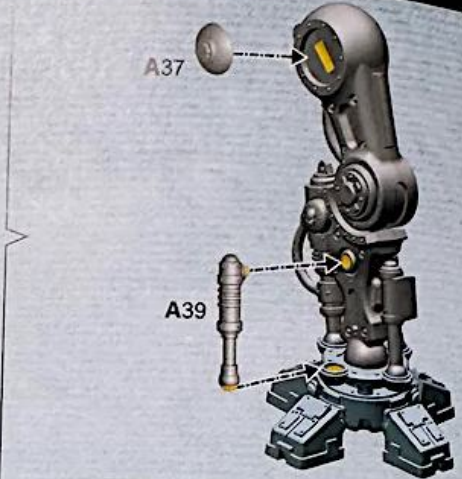
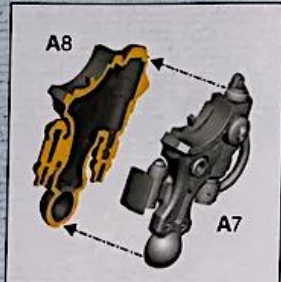

2

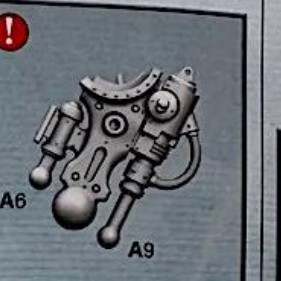
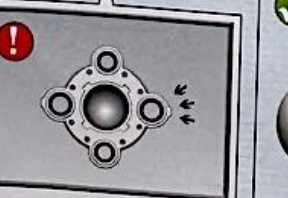
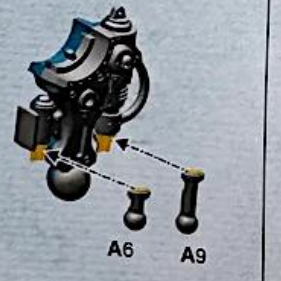
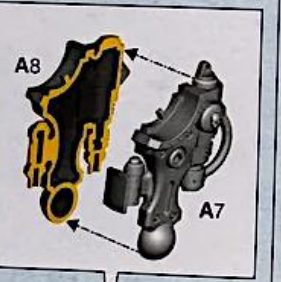

3 a

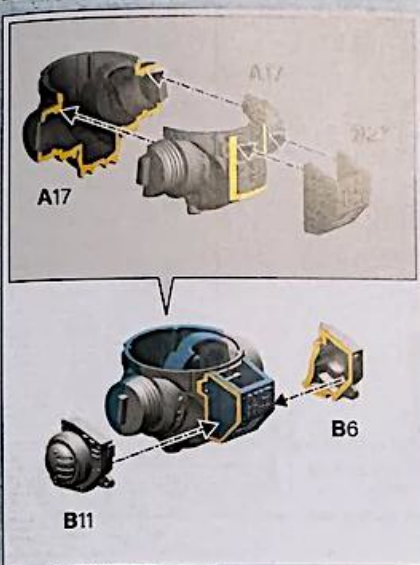

3 b

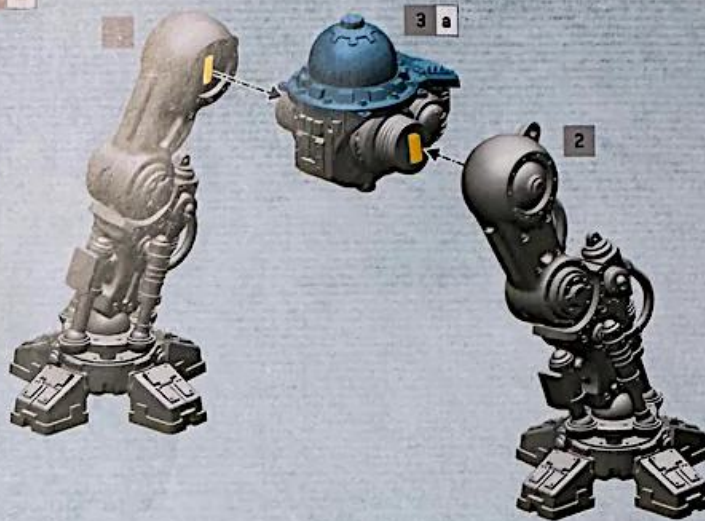

3 c

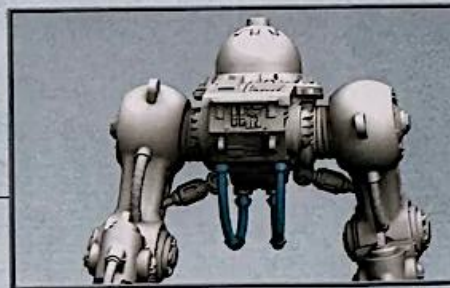
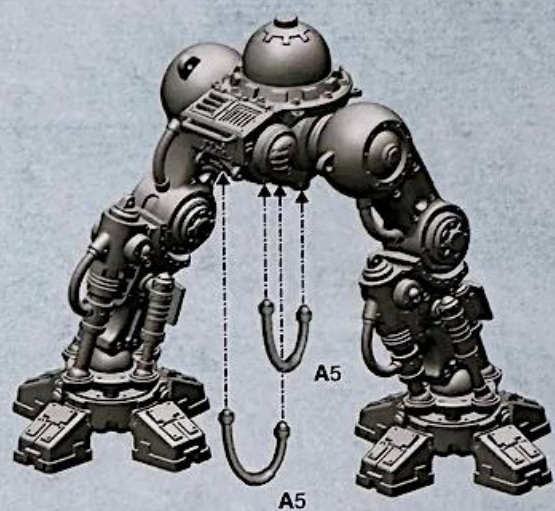
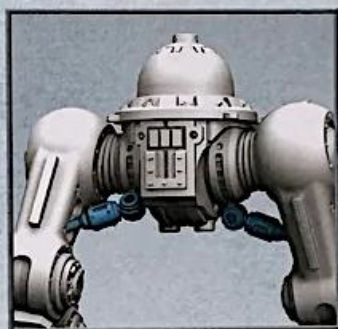
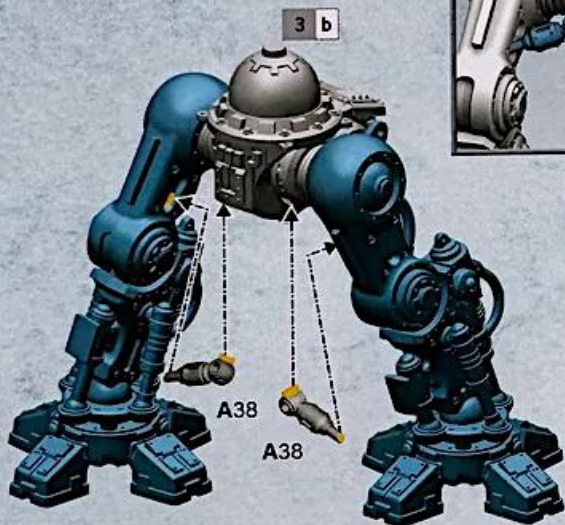

3 d

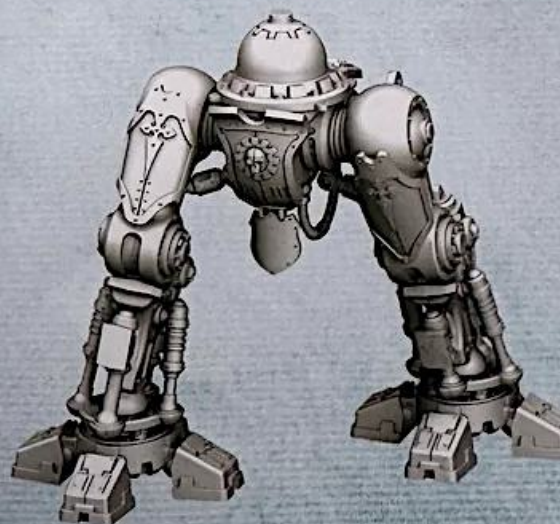
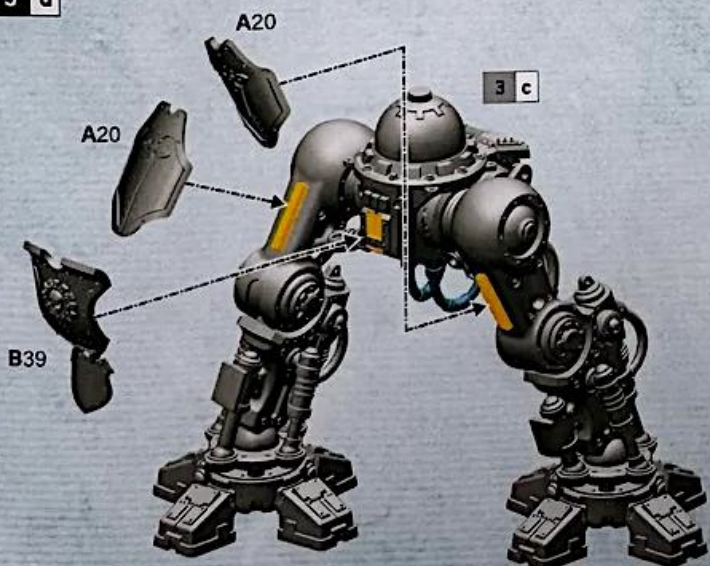

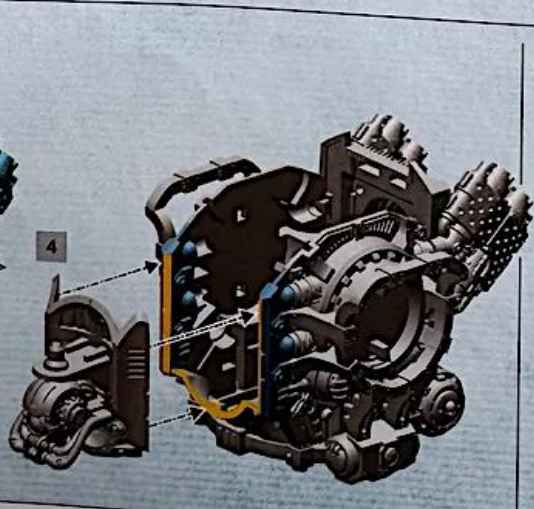
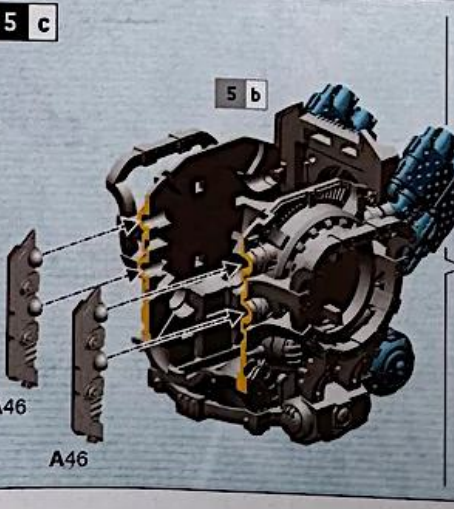
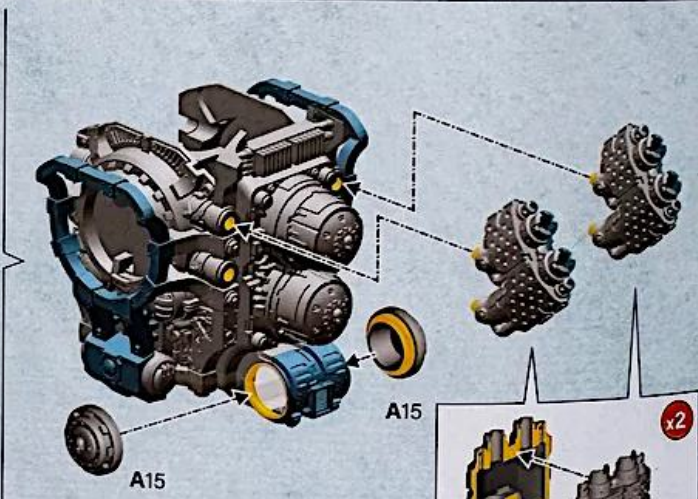
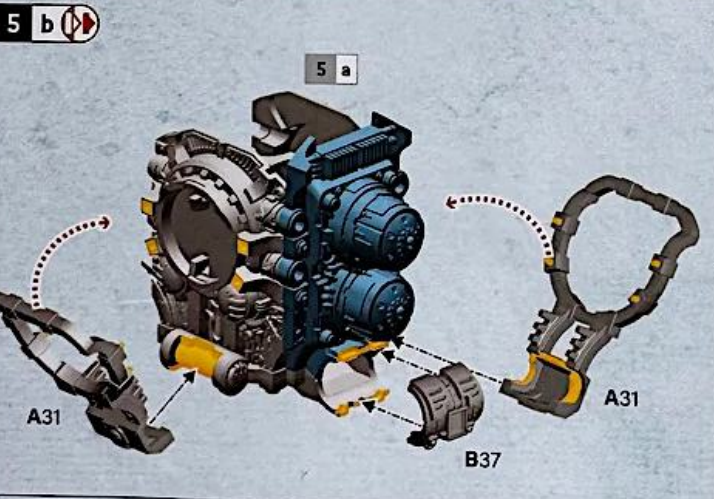
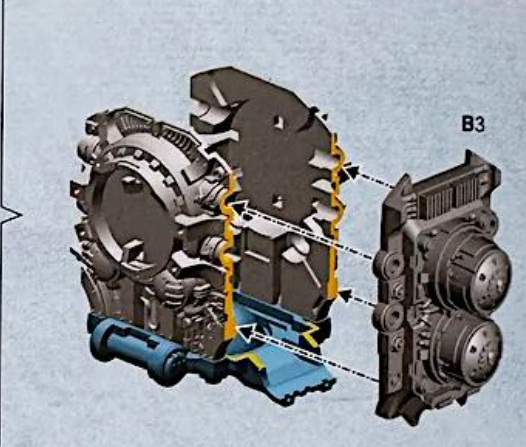
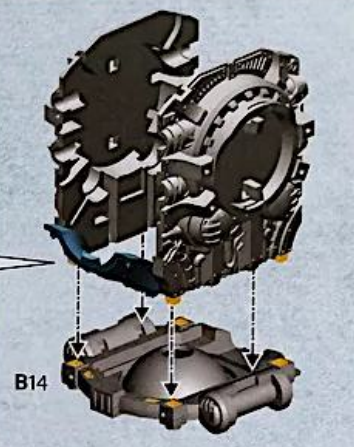
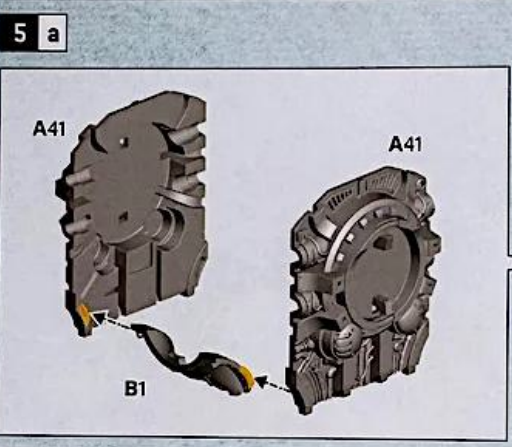
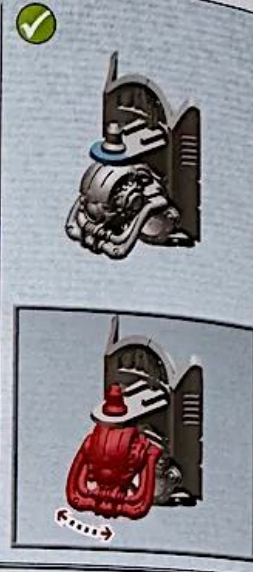
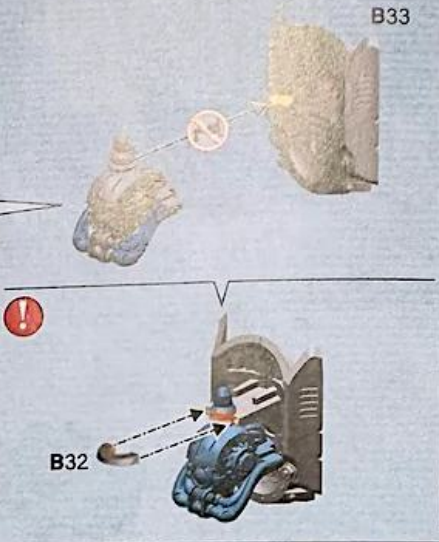
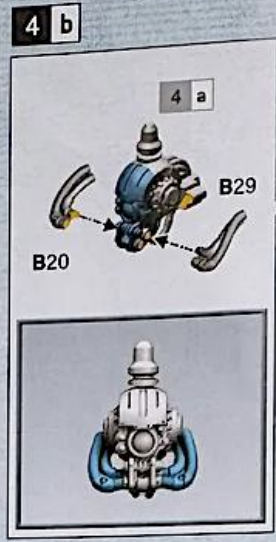
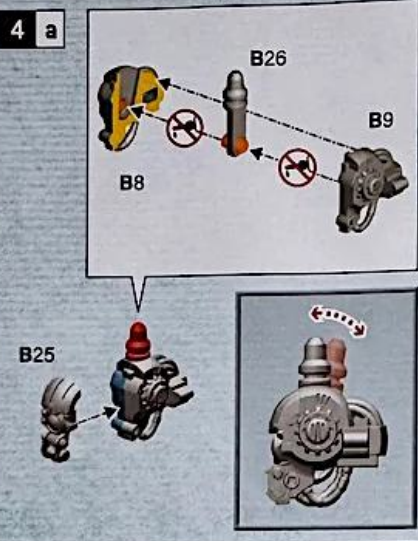

6 x2

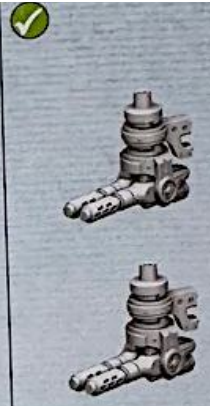
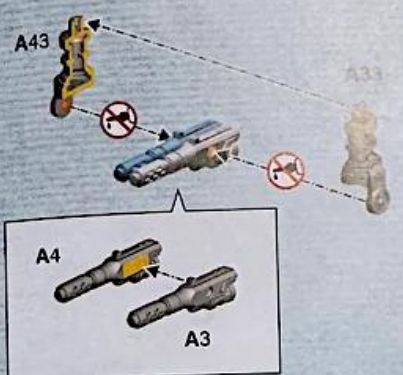

7 a

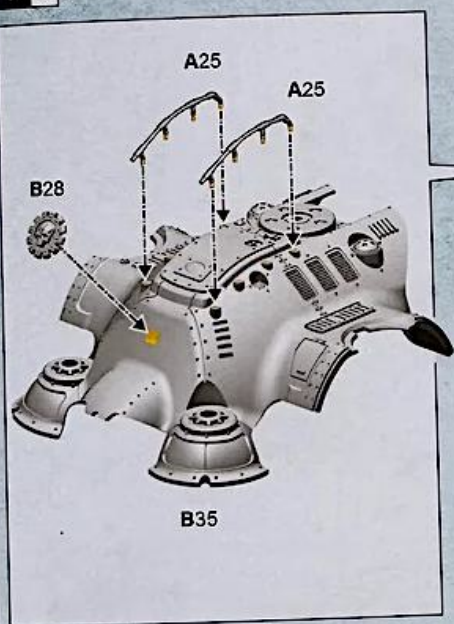

7 b

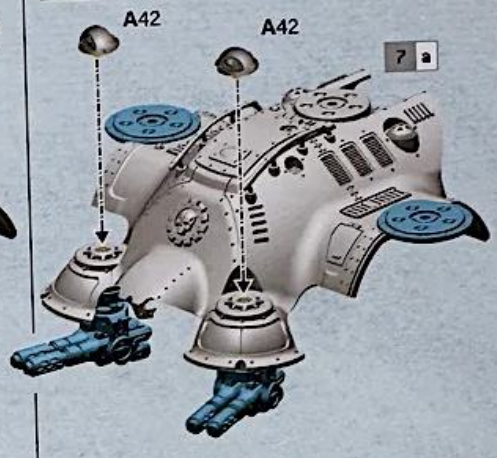

7 c

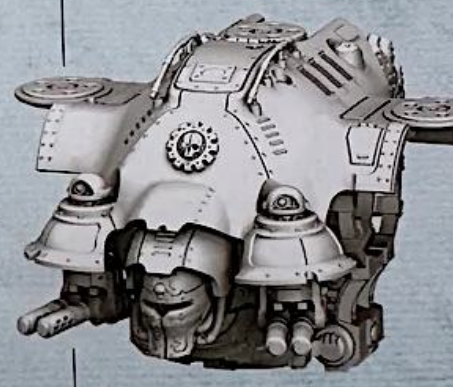
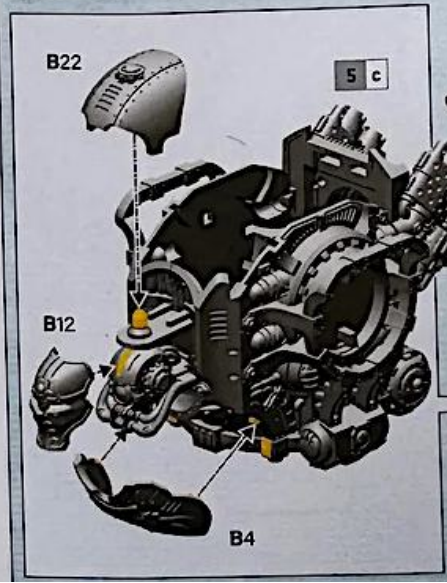

8 a

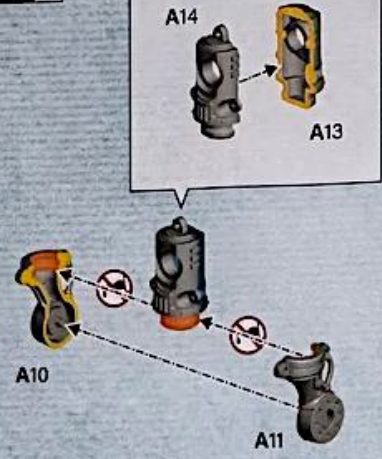

B17

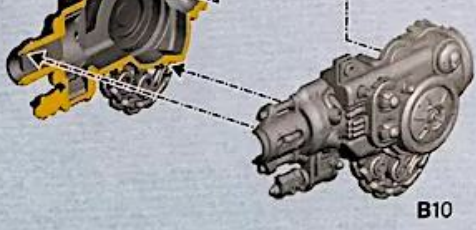

B19

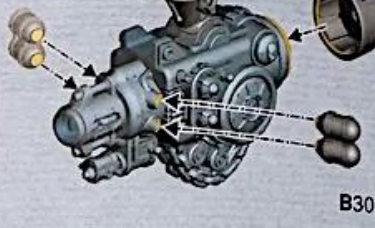

B49

B30

8 b

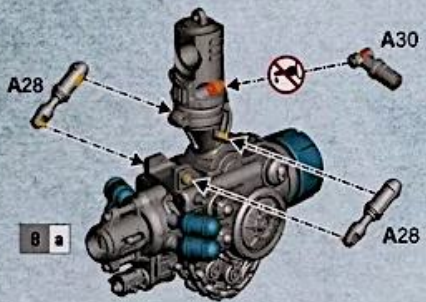

A32



8 c

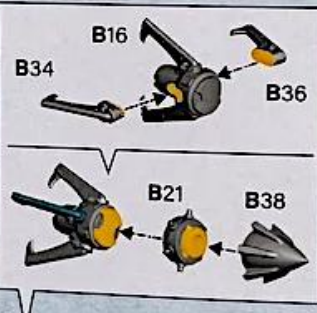
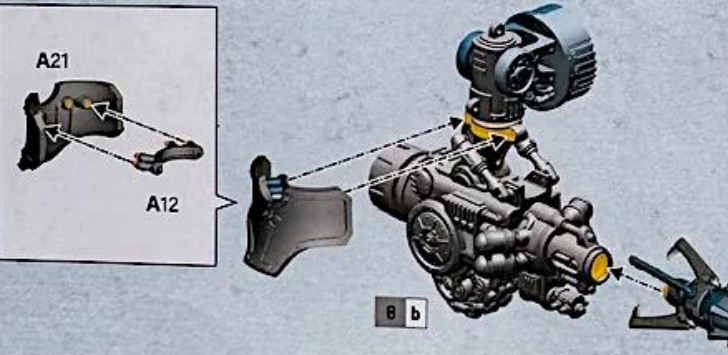

9 a

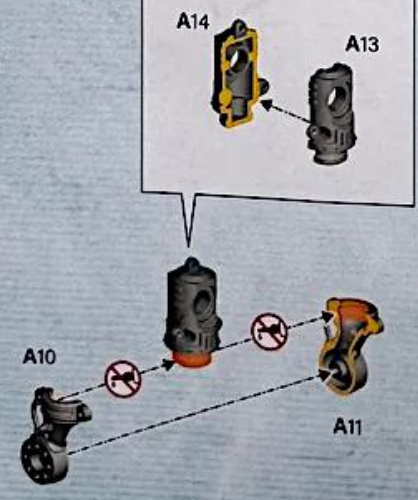

B31

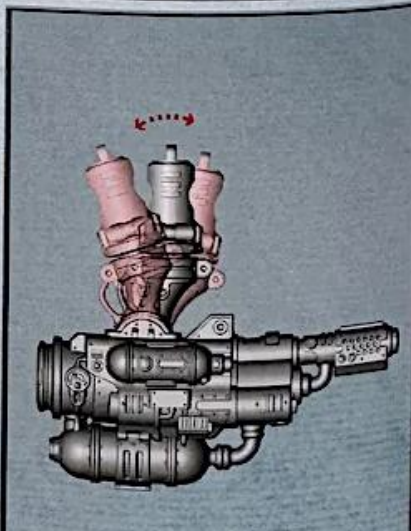

9 b

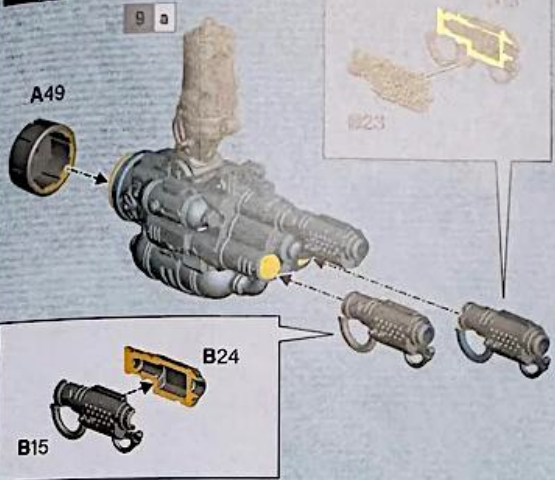

A30



B7

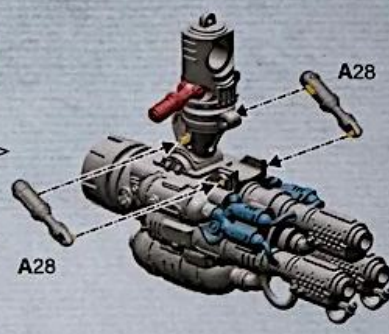

9 c

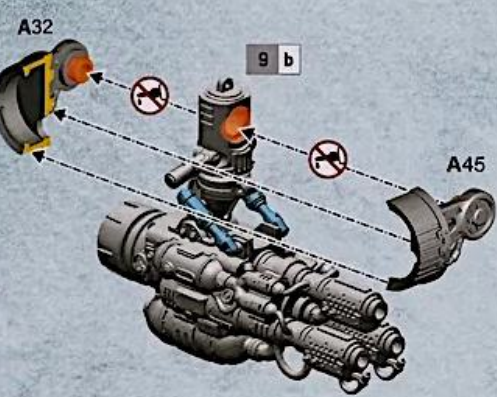

9 b

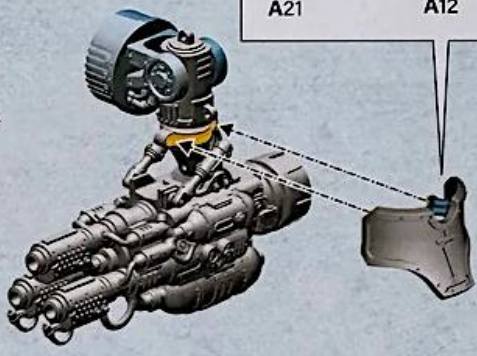

A21

A12



10 a

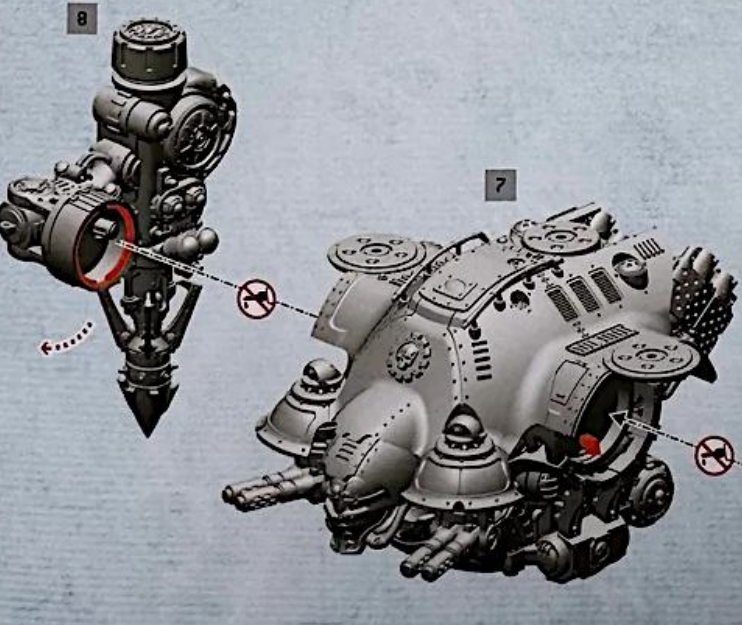

9

10 b



10 c 

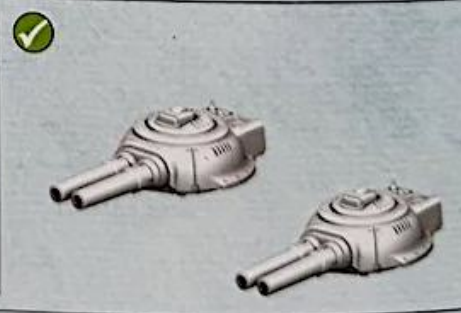
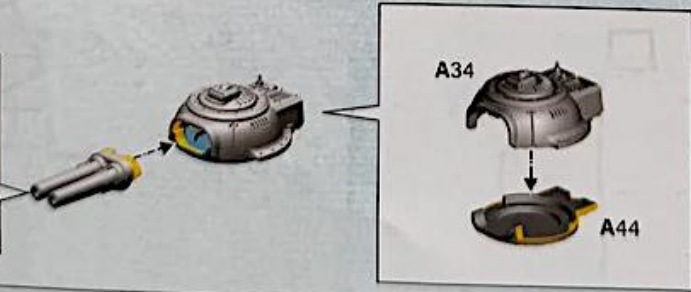
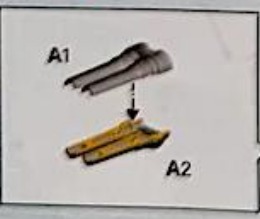

10 d 

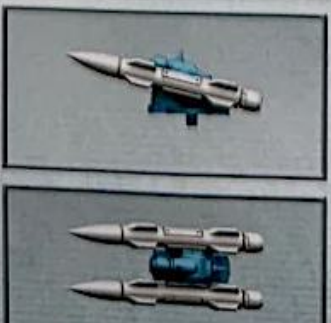
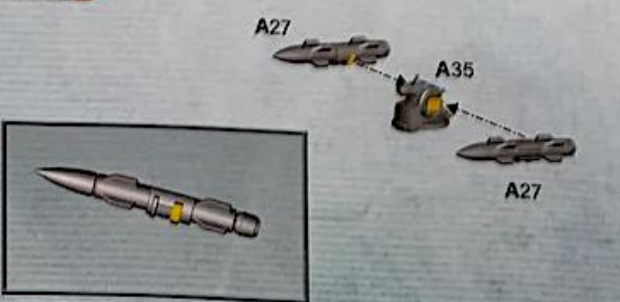

10 e

10 d

c

10 d

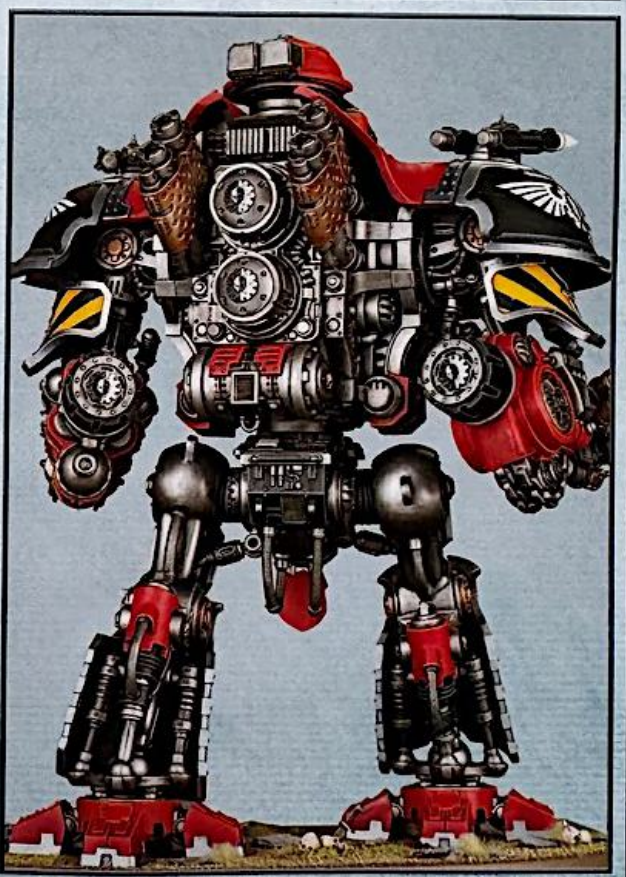
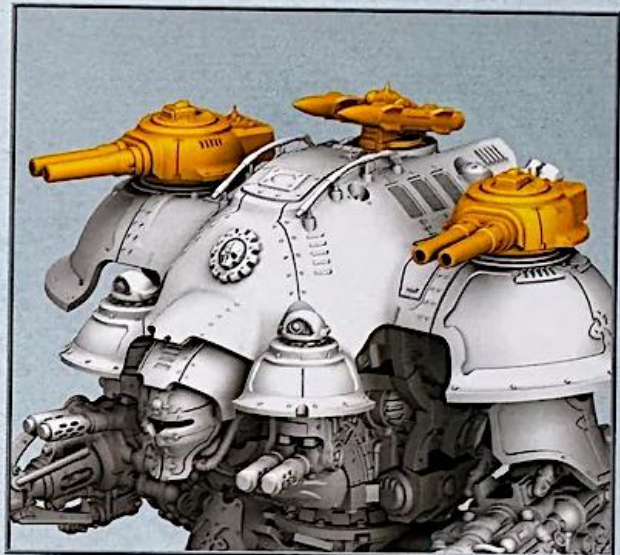
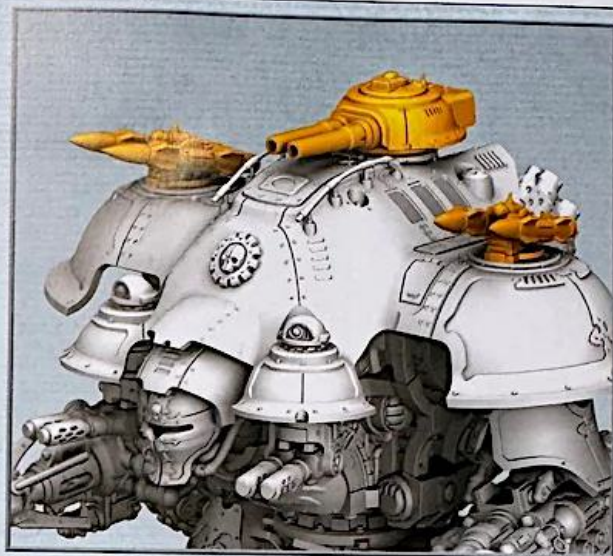

11

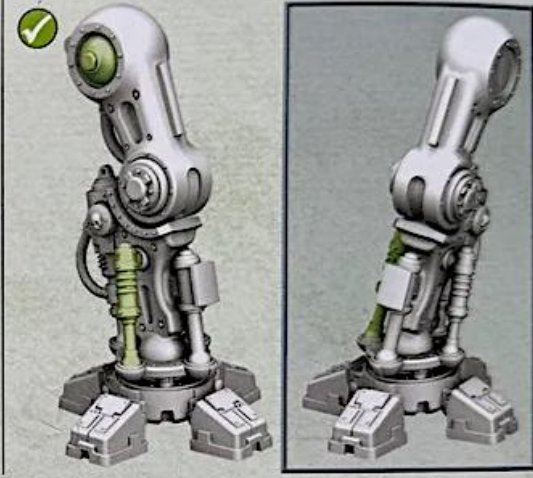
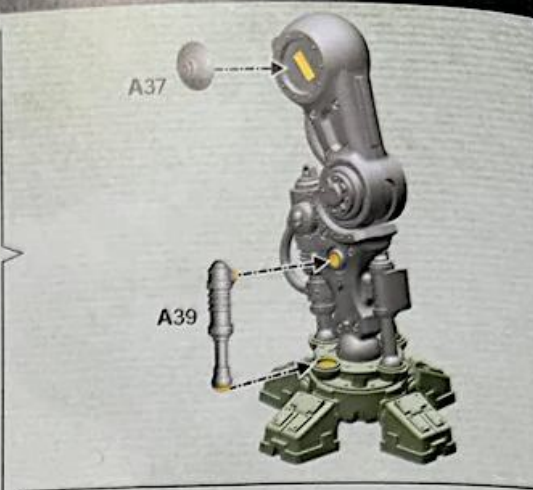
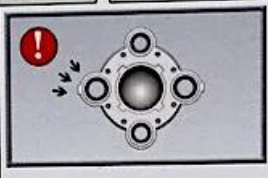
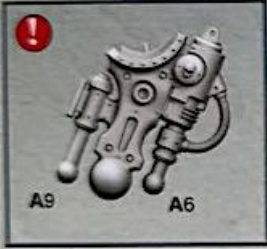
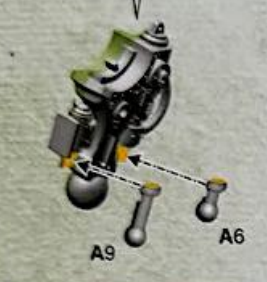
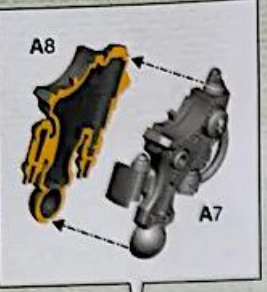

12

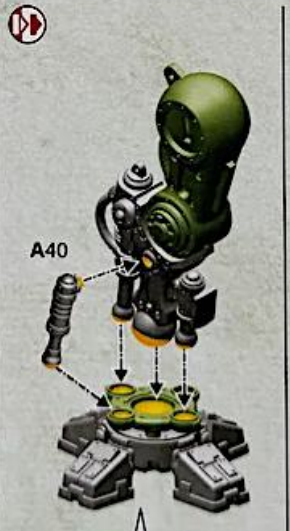
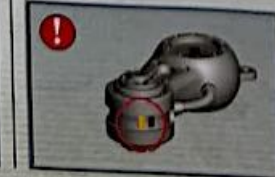
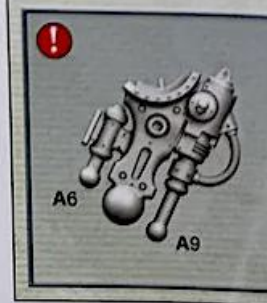

13 a

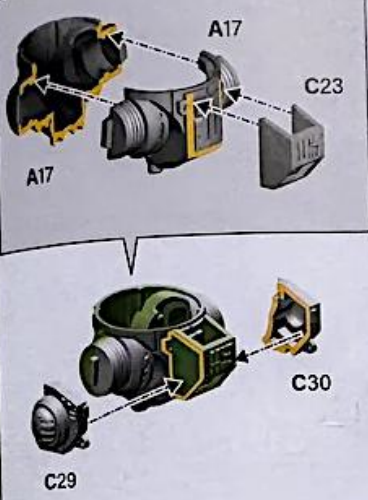

13 b

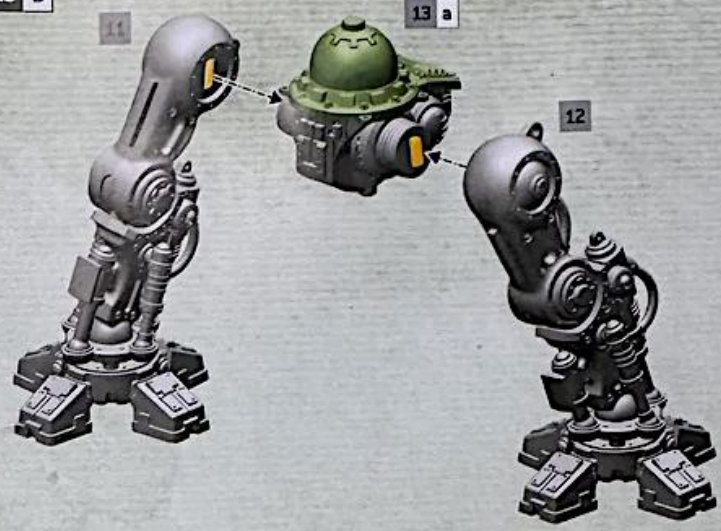

13 c

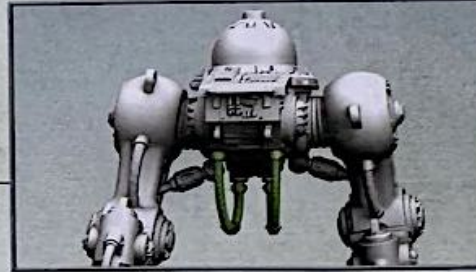
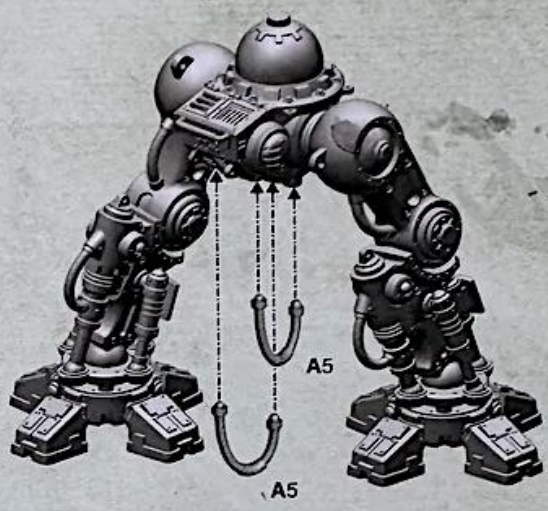
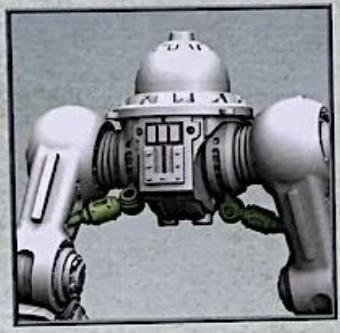
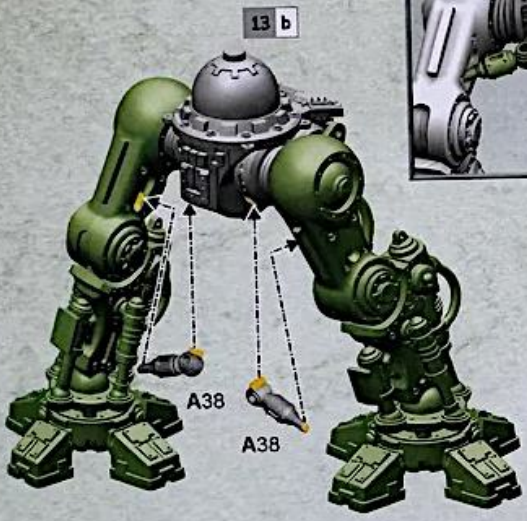

13 d

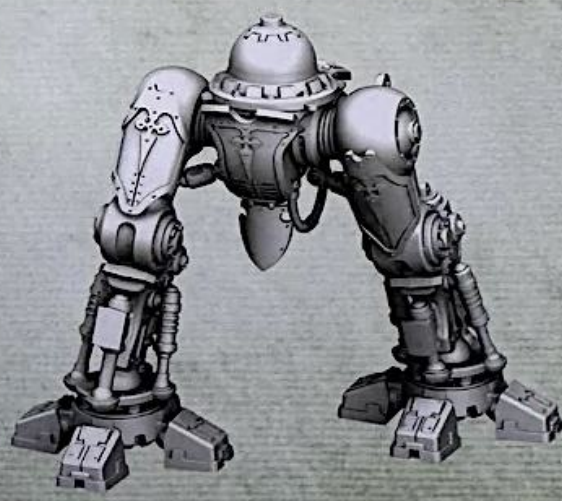
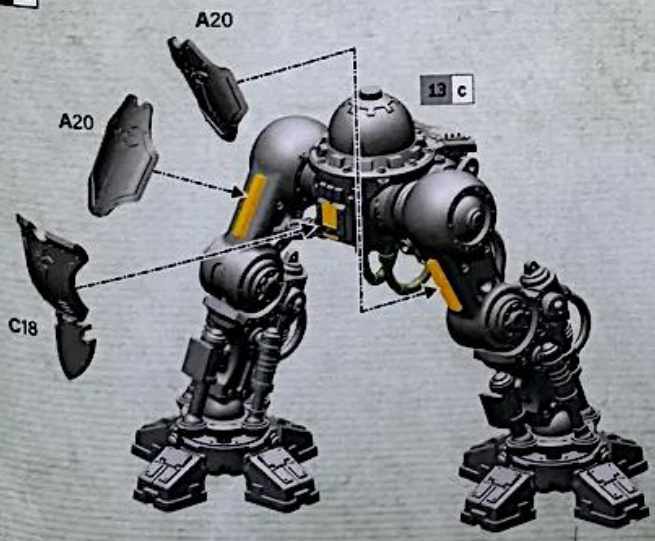

14 a

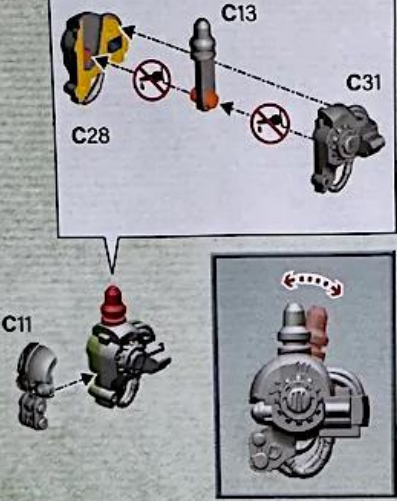

14 b

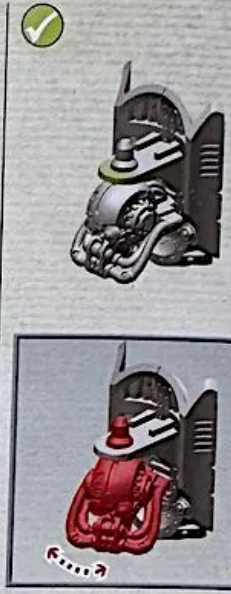
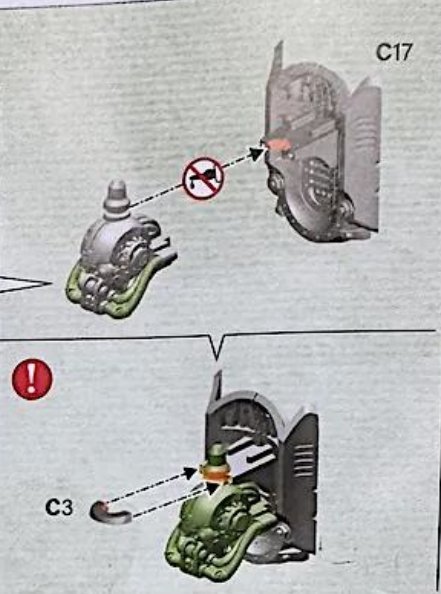
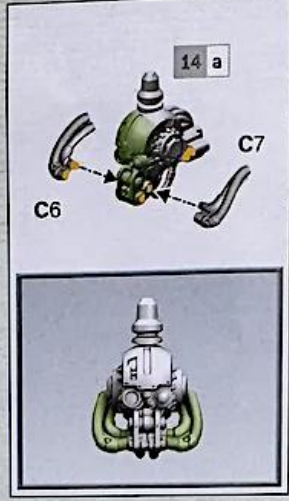

15 a

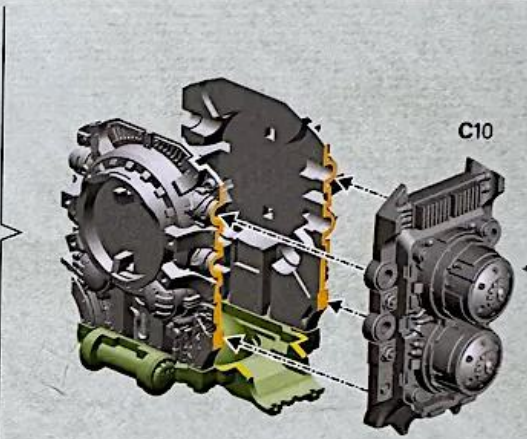
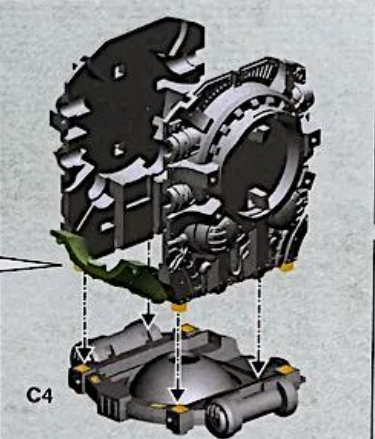
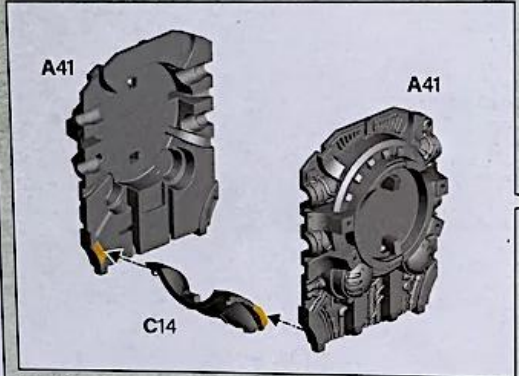

15 b

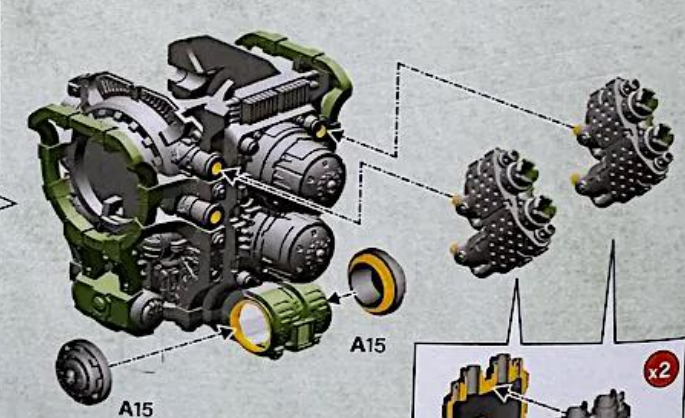
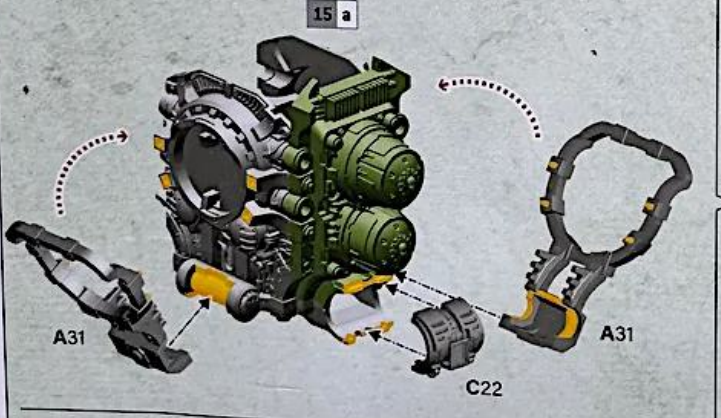

15 c

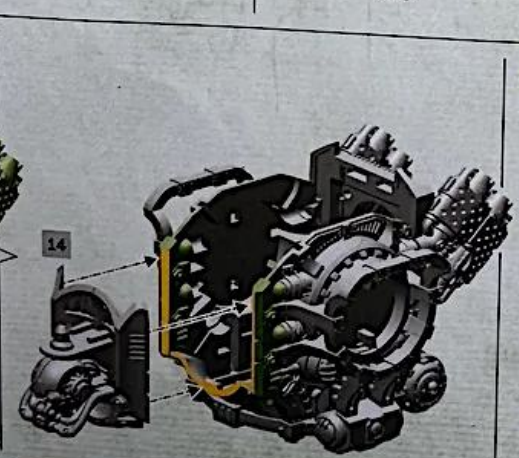
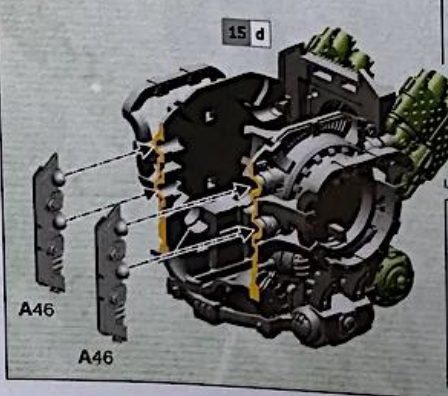

16 x2

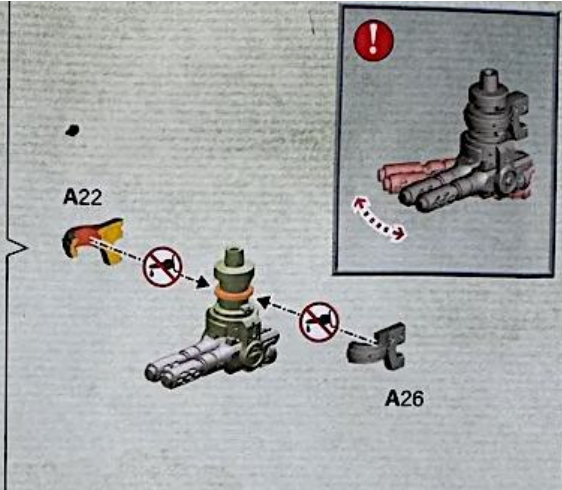
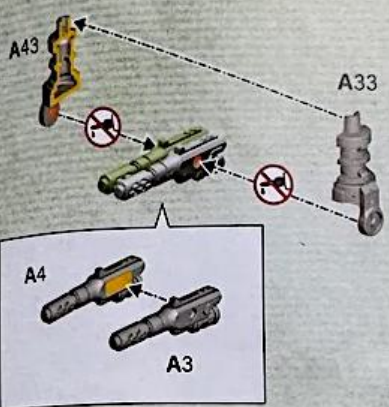

17 a

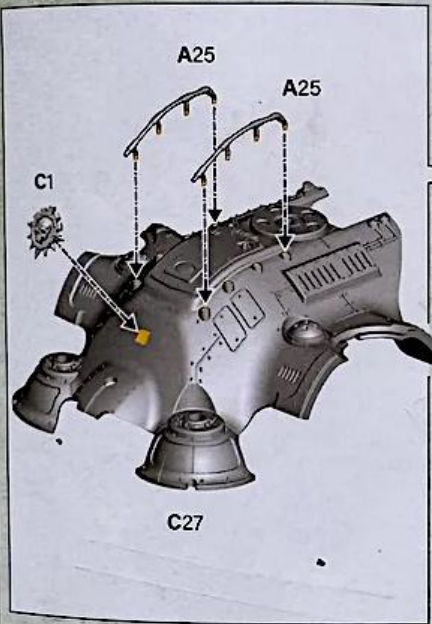

17 b

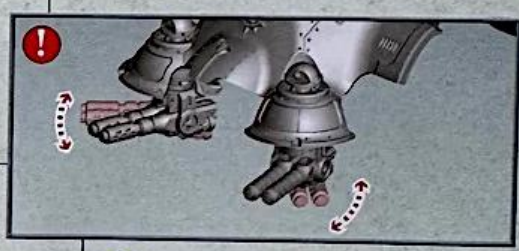
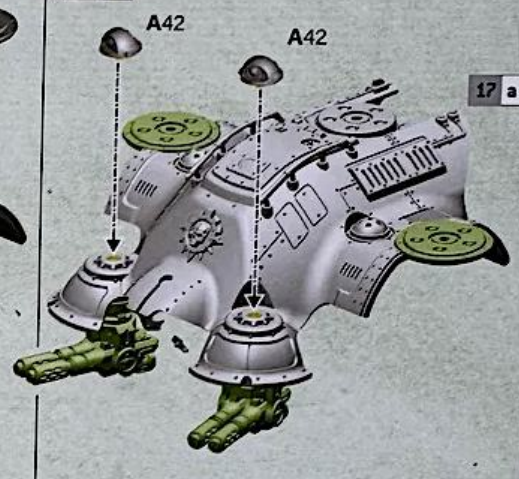

17 c

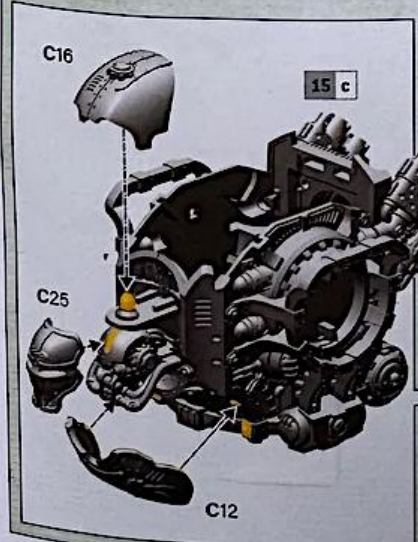

17 d

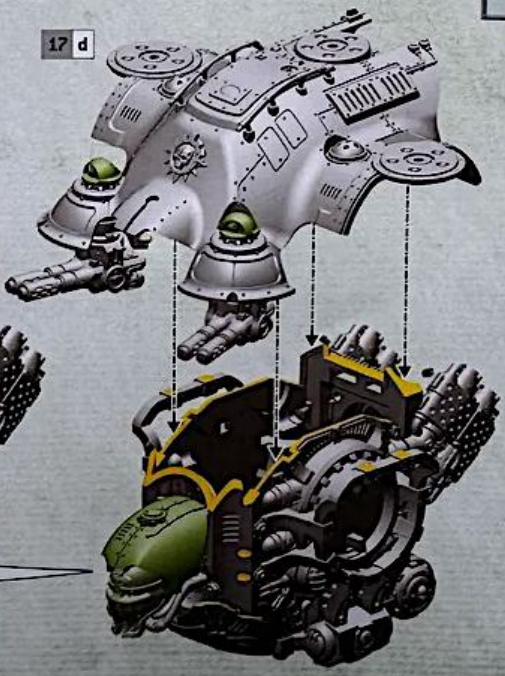

17 e



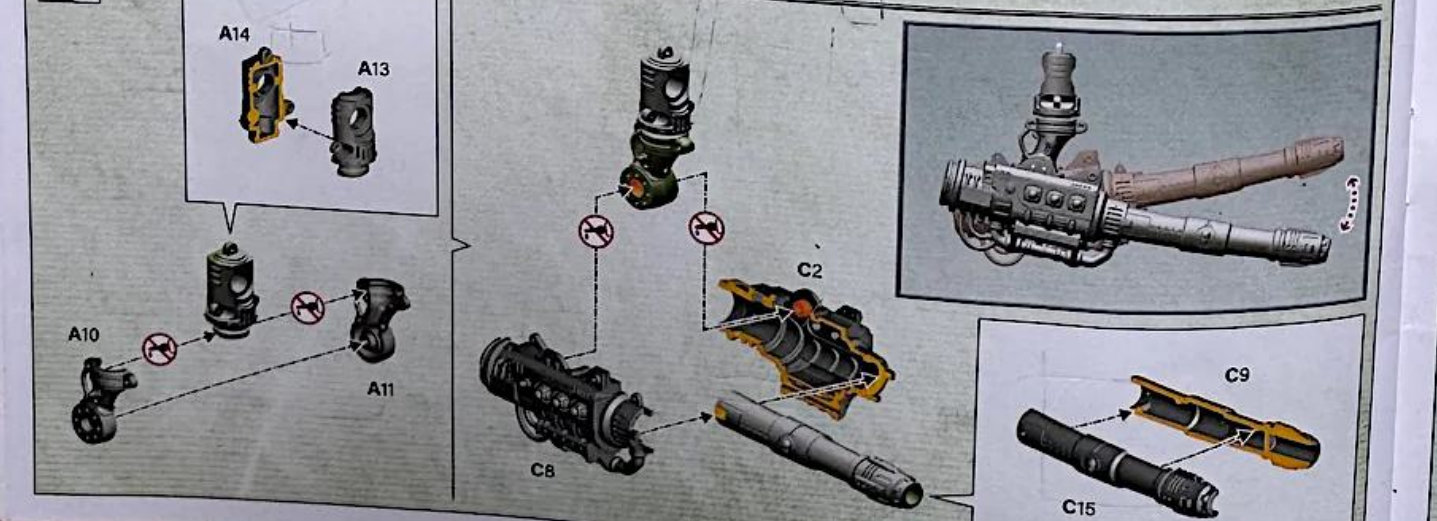
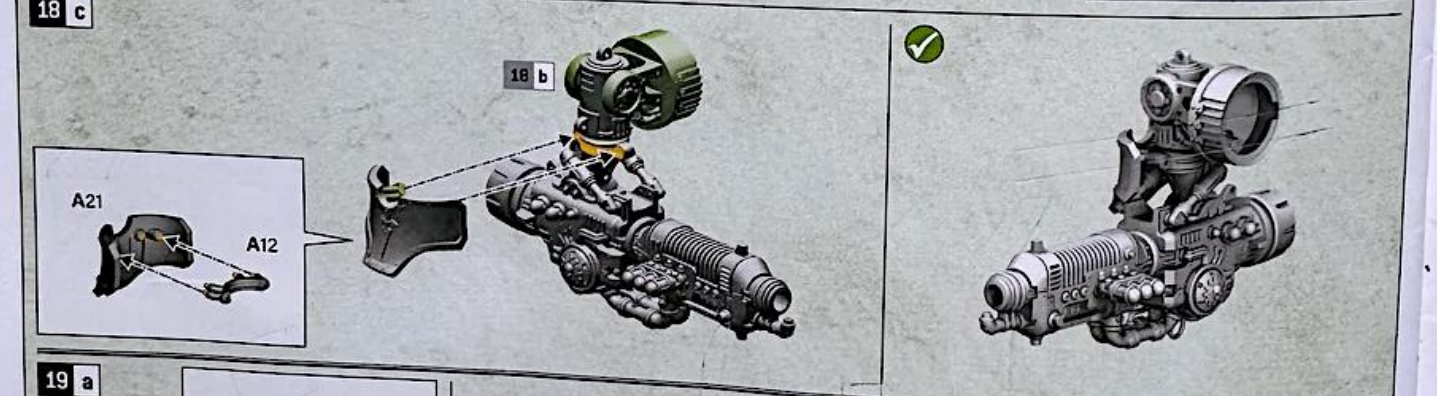
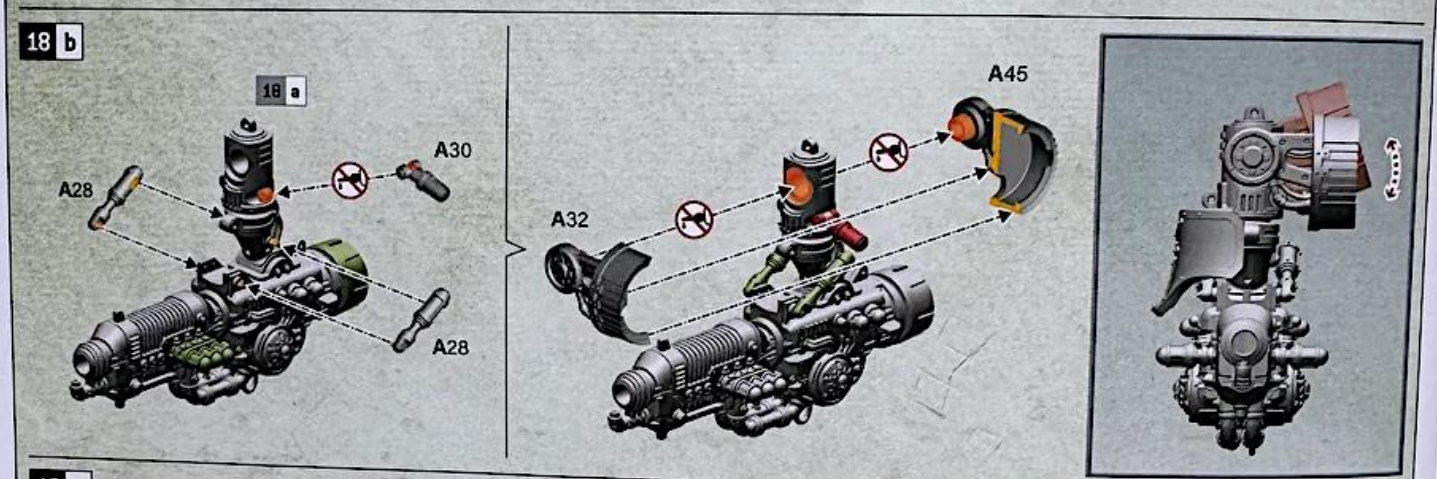
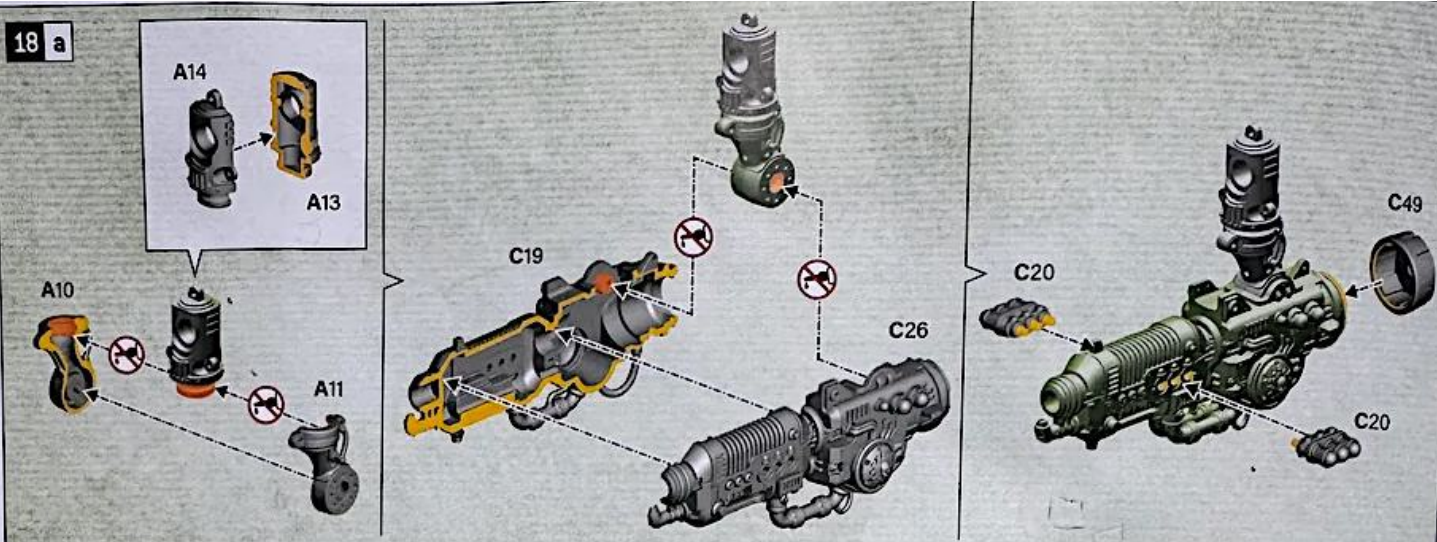

19 b

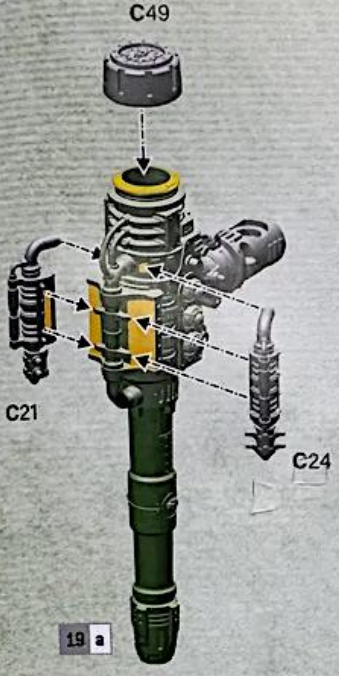

19 a

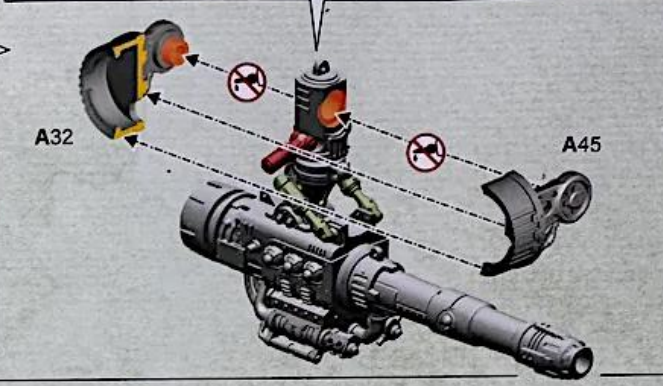
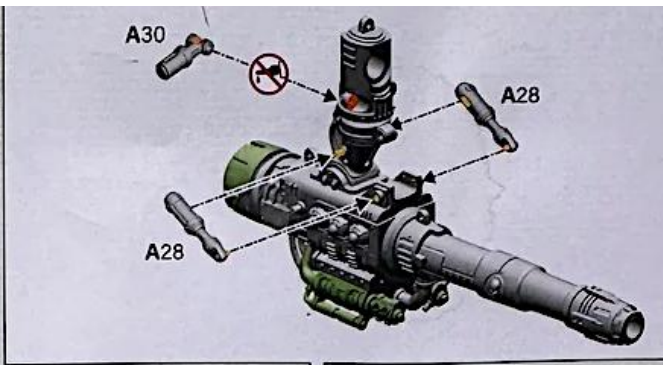

19 c

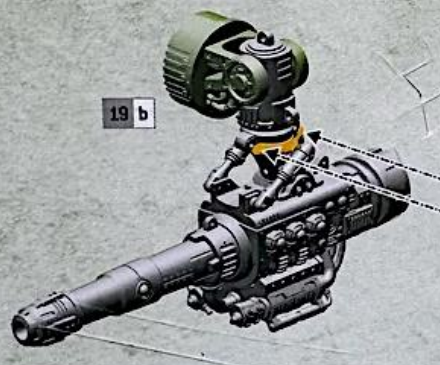

19 b

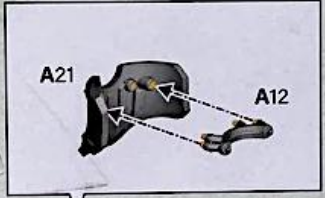

20 a



18



17



19

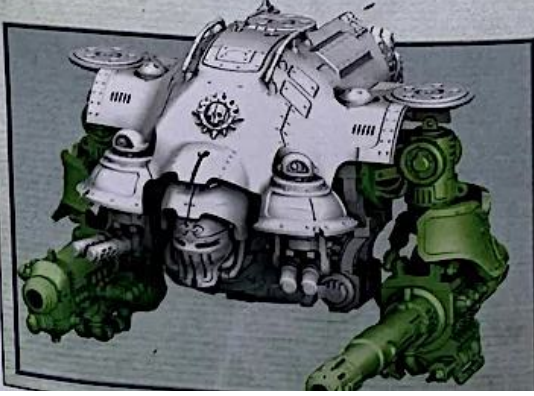

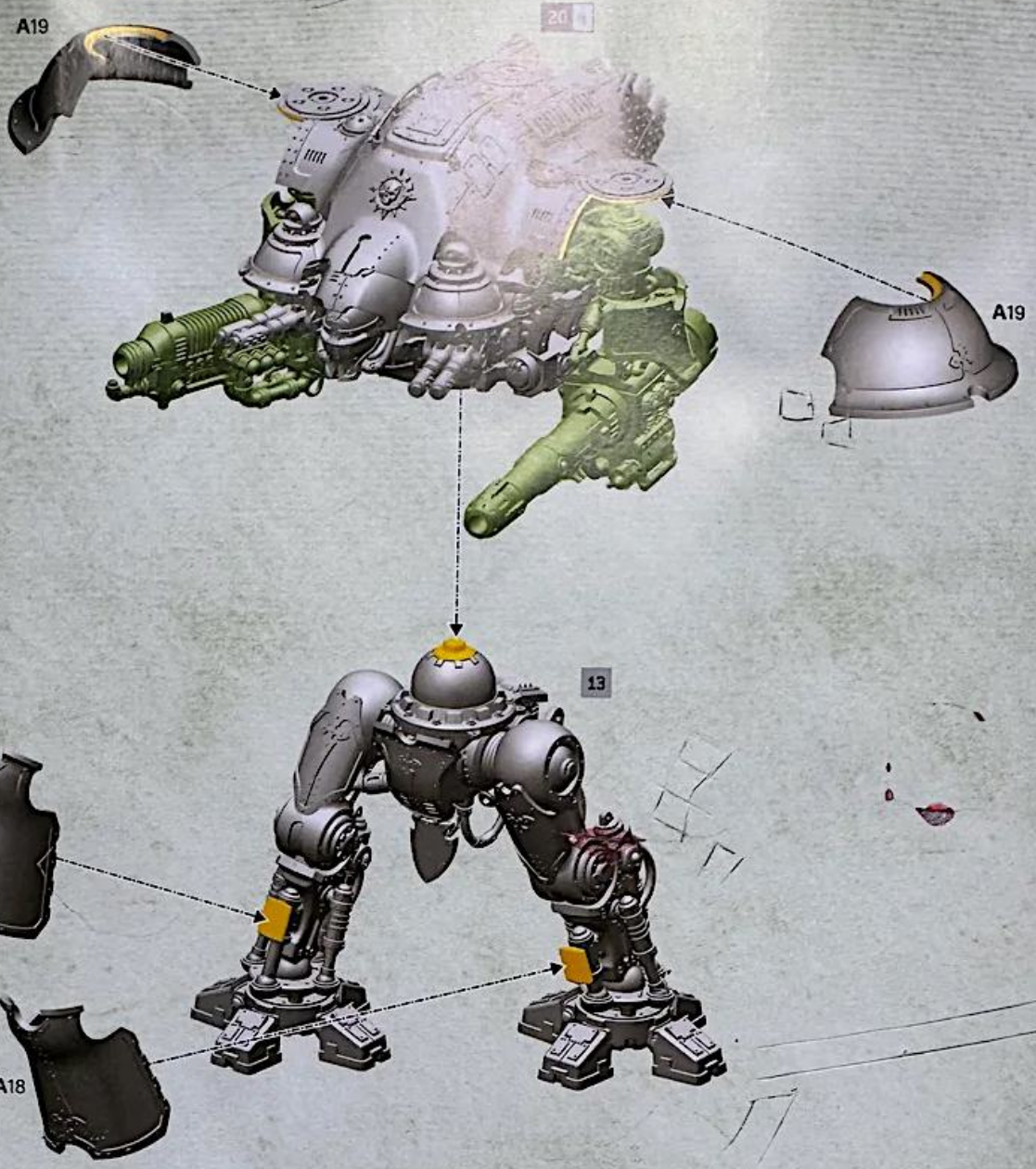

20 c x2



20 d x2

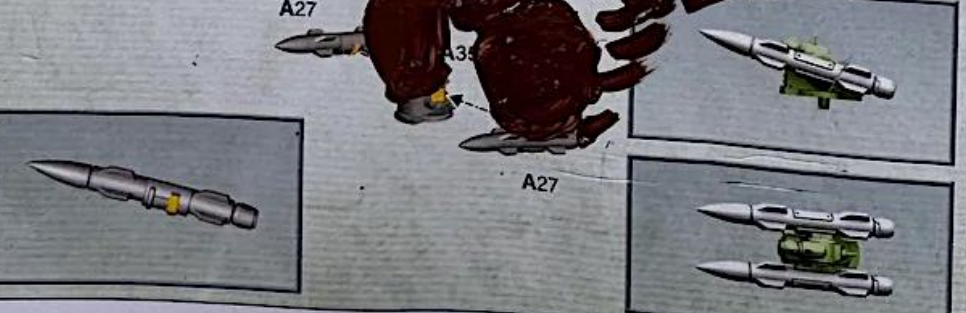

20 e

20 d

20 c

20 c

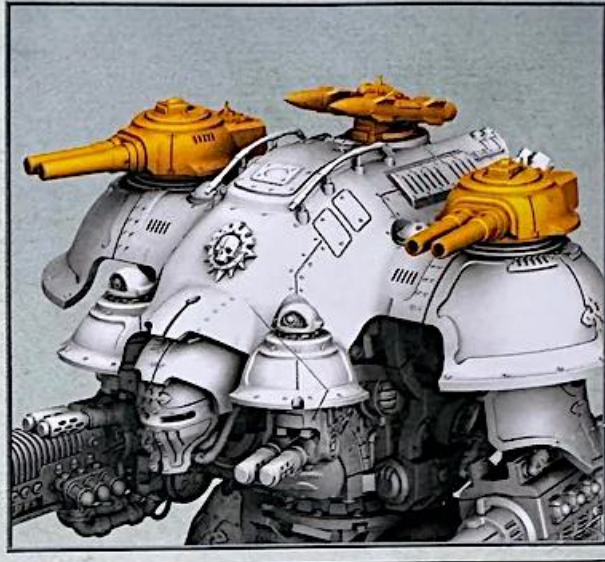
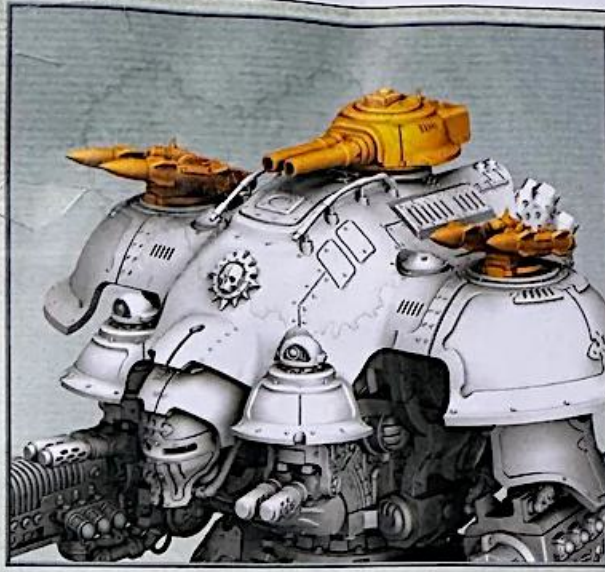

✓

