



Free Downloads of Build Instructions,  
Assembly Booklets & How To Guides

**BuildInstructions.com**

# WARHAMMER 40,000



## WRAITHKNIGHT

CHEVALIER FANTÔME | CABALLERO ESPECTRAL | PHANTOMRITTER | SPETTROCAVALIERE | レイスナイト | 幽騎騎士

READ THIS FIRST | À LIRE EN PRIORITÉ | BITTE BEACHTE | LEE ESTO PRIMERO | LEGGI PRIMA QUESTO | 最初にお読みください。| 请优先阅读

**ENG.** BEFORE ASSEMBLING YOUR MINIATURES, PLEASE READ THROUGH THE INSTRUCTIONS IN THIS BOOKLET CAREFULLY. A pair of plastic cutters is required to remove the plastic components in this kit from their frame. We advise using a mouldline scraping tool to clean up the parts. To assemble your model you will need plastic glue. Games Workshop sells Citadel Fine Detail Cutters, Citadel Mouldline Remover and Citadel Plastic Glue, but does not recommend these products for use by children under the age of 16 without adult supervision.

**FRE.** AVANT D'ASSEMBLER VOS FIGURINES, VEUILLEZ LIRE ATTENTIVEMENT LES INSTRUCTIONS DE CE LIVRET. Une pince coupante est requise pour détacher chaque élément de sa grappe. Nous vous recommandons l'utilisation d'un grattoir pour ébarber les éléments. Pour l'assemblage, vous aurez également besoin de colle plastique. Games Workshop commercialise les Pinces de Précision Citadel, l'Ébarboir Citadel et la Colle Plastique Citadel, mais n'en recommande pas l'utilisation pour des enfants de moins de 16 ans sans la supervision d'un adulte.

**ESP.** POR FAVOR, LEE CUIDADOSAMENTE ESTE LIBRETO DE INSTRUCCIONES ANTES DE EMPEZAR A MONTAR LAS MINIATURAS. Te harán falta unas tenazas para plástico a fin de separar las piezas de la matriz. También aconsejamos una herramienta para rebabas a fin de limpiar cada pieza. Para montar la miniatura necesitarás pegamento para plástico. Games Workshop vende Tenazas Citadel, Herramientas para rebabas Citadel y Pegamento para plástico Citadel, pero no recomienda estos productos a menores de 16 años sin la supervisión de un adulto.

**GER.** VOR DEM ZUSAMMENBAU DER MINIATUREN BITTE DIE ANWEISUNGEN IN DIESER ANLEITUNG AUFMERKSAM DURCHLESEN. Du benötigst einen

Kunststoffseitenschneider, um die Kunststoffbauteile aus dem Gussrahmen herauszutrennen, und Kunststoffkleber, um die Miniatur zusammenzubauen. Außerdem empfehlen wir, die Bauteile vorher mit einem Gussgratentferner zu säubern. Games Workshop bietet Präzisions-Kunststoffseitenschneider von Citadel sowie Citadel-Kunststoffkleber an, empfiehlt aber, dass Kinder unter 16 Jahren diese nur unter Aufsicht eines Erwachsenen benutzen.

**ITA.** PRIMA DI ASSEMBLARE LE TUE MINIATURE LEGGI ATTENTAMENTE TUTTE LE ISTRUZIONI DI QUESTO LIBRETTO. Sono necessarie un paio di tronchesine per plastica per staccare i componenti dai loro sprue. Consigliamo di usare un attrezzo apposito per pulire i componenti. Per assemblare il modello avrai bisogno di colla per plastica. Games Workshop vende Tronchesine di precisione Citadel, Attrezzo per ripulire Citadel e Colla per plastica Citadel, ma non consiglia questi prodotti ad un pubblico minore di 16 anni senza la supervisione di un adulto.

**CHN.** 本キット内のフレームからプラスチックパーツを切り離すためには、ニッパーが必要です。パーツのモールドを平らにするには、専用ツールの使用をお勧めいたします。本キットの組み立てには、プラ用接着剤が必要です。ゲームズワークショップはシタデル・ニッパー、プラ用接着剤、シタデル・モールドラインリムーバーを販売しておりますが、16歳以下の子供が大人の監督なしにこれらの道具を使用されることをお勧めしません。

**JPN.** 你需要一把模型剪將塑料部件從框上剪下來。我們建議使用分模刮刀來處理零件。組裝時你還需要用到模型膠水。你可以從 Games Workshop 處購買到 Citadel Fine Detail Cutter 模型剪、Citadel Mouldline Remover 分模刮刀和 Citadel Plastic Glue 模型膠。但 16 歲以下兒童不得在沒有成年人監督的情況下使用這些產品。



ENG More painting guides can be found on [citadelcolour.com](http://citadelcolour.com)  
 FRE D'autres guides de peinture sont disponibles sur [citadelcolour.com](http://citadelcolour.com)  
 ESP Encontrarás más guías de pintura en [citadelcolour.com](http://citadelcolour.com)  
 GER Weitere Bemalungsleitungen auf [citadelcolour.com](http://citadelcolour.com)

ITA Puoi trovare altre guide alla pittura su [citadelcolour.com](http://citadelcolour.com)  
 日本語 [citadelcolour.com](http://citadelcolour.com)には他にも様々なペイントガイドが掲載されている  
 中文 更多涂装指南请至 [citadelcolour.com](http://citadelcolour.com)

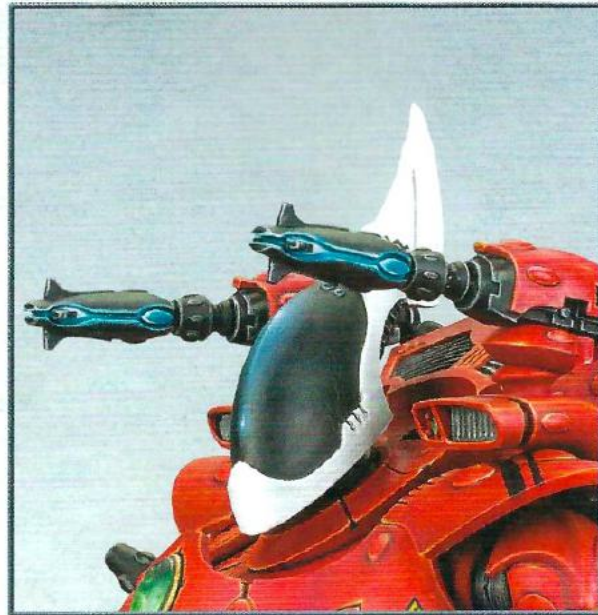

BUILD VARIANTS | VARIANTES D'ASSEMBLAGE | VARIANTES DE MONTAJE | BAUVARIANTEN | VARIANTI D'ASSEMBLAGGIO | バリエーション | 变体版



- Assemblies for build variants are colour coded.
- Les assemblages de variantes ont un code couleur.
- Las instrucciones para montajes alternativos se indican con un color diferente.
- Optionen für Bauvarianten sind farblich markiert.
- Le diverse varianti d'assemblaggio sono divise per colore.
- バリエーション違いの組み立ては色分けされている。
- 变体版拼装部件有颜色区分。

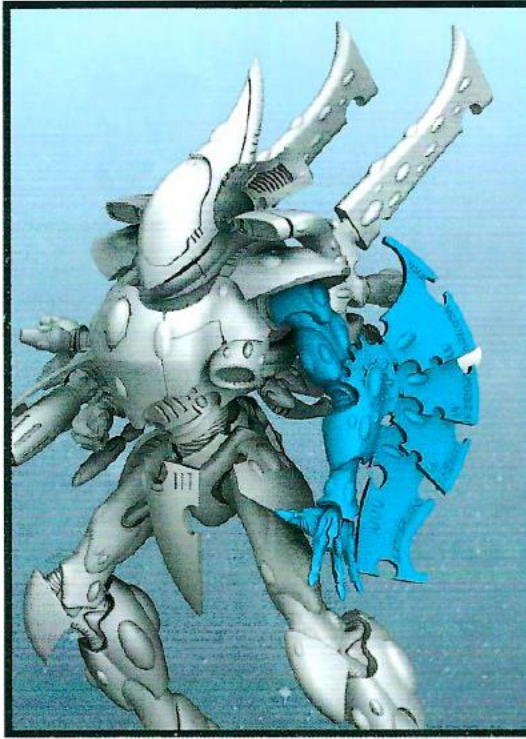

EXPLANATION OF SYMBOLS | EXPLICATION DES SYMBOLES | EXPLICACIÓN DE SÍMBOLOS | ERLÄUTERUNG DER SYMBOLE | LEGENDA DEI SIMBOLI | アイゴン解説 | 符号说明



- Special instruction - Please read
- Instructions spéciales - Lire attentivement
- Instrucción especial: Por favor, léela
- Besondere Anweisung - Bitte lesen
- Istruzioni speciali - Leggi attentamente
- 特記事項 - 必ずお読みください
- 特殊说明 - 请详阅



- Dry fit stage before gluing
- Tester avant de coller
- Comprobar el encaje antes de pegar
- Positionierung erst ohne Klebstoff ausprobieren
- Prova a secco prima di incollare
- 接着前にぴったり合わせることを粘接前の假組阶段



- Assembly sequence
- Séquence d'Assemblage
- Secuencia de montaje
- Baureihenfolge
- Sequenza di assemblaggio
- 組み立て手順
- 拼装顺序



- Variant assembly
- Variante d'assemblage
- Variante de montaje
- Bauvariante
- Assemblaggio alternativo
- 組み立てバリエーション
- 多种组装方式



- Choice of parts
- Choix d'éléments
- Modelos de componentes
- Auswahl an Teilen
- Scelta di componenti
- パーツの選択
- 选择部件



- Stage complete
- Etape terminée
- Paso completado
- Schritt abgeschlossen
- Fase completa
- このステージの完成
- 完成

1 a

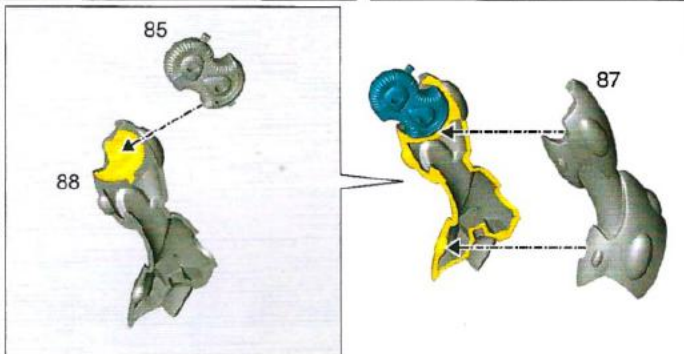
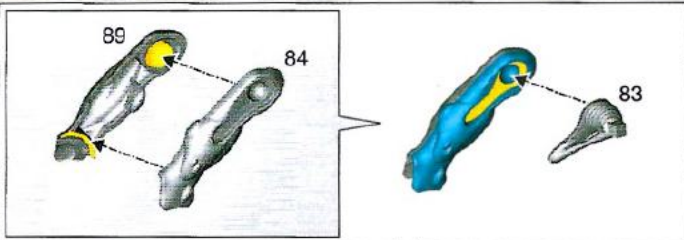

1 b

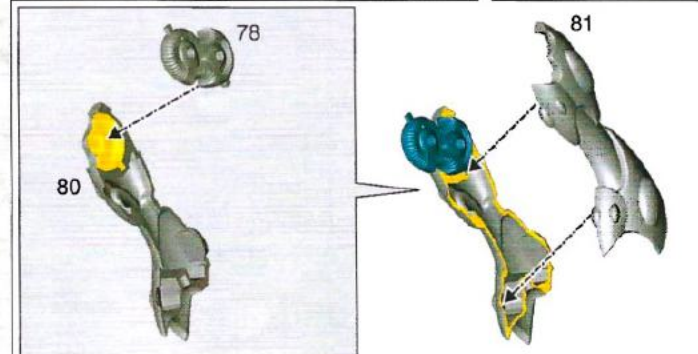
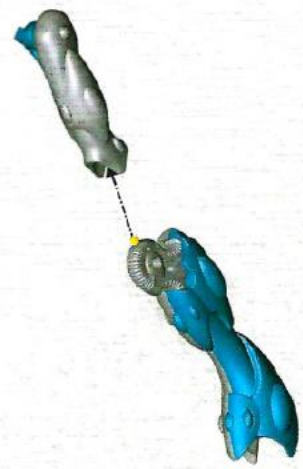
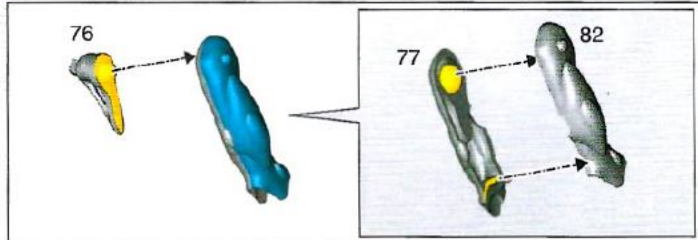

1 c

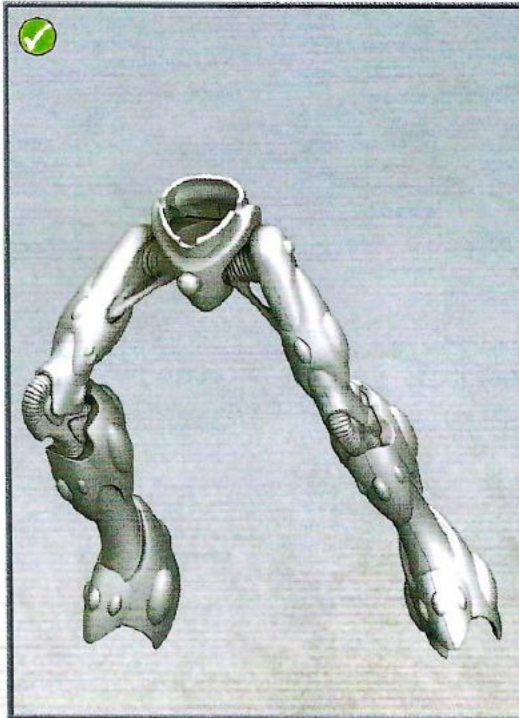
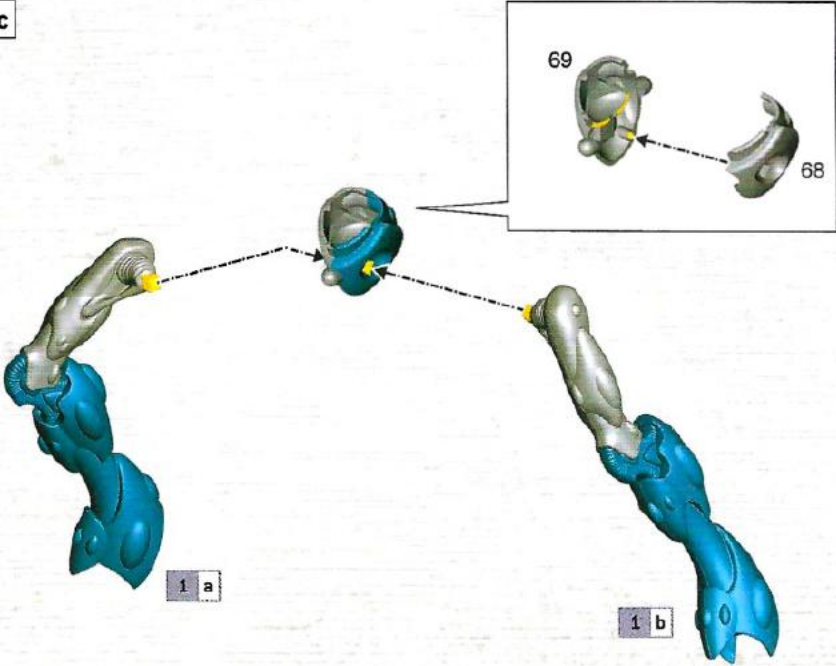

1 d

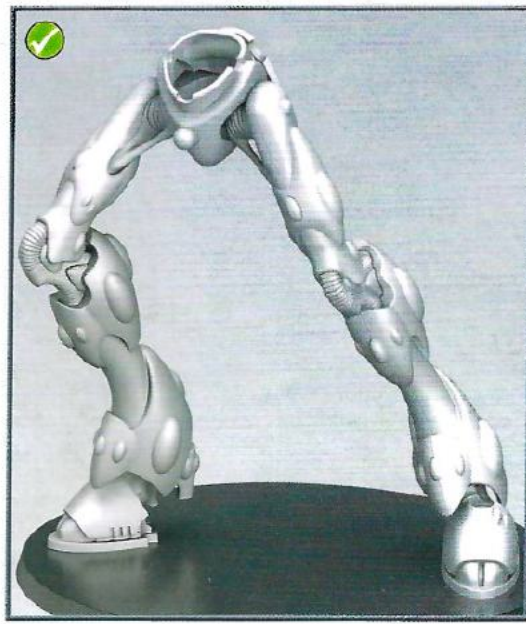
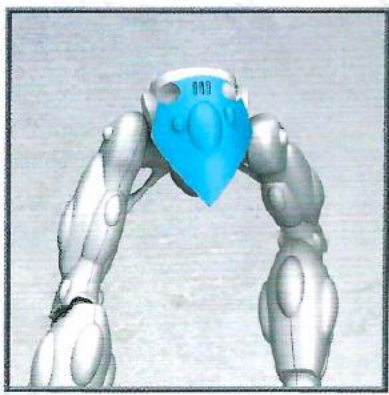
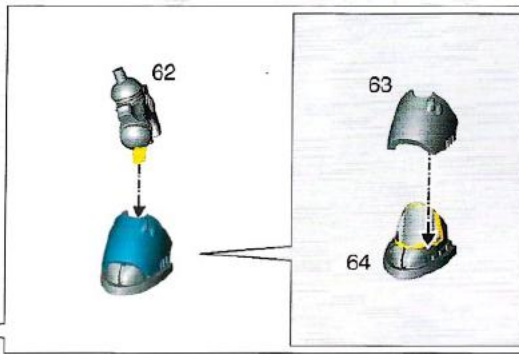
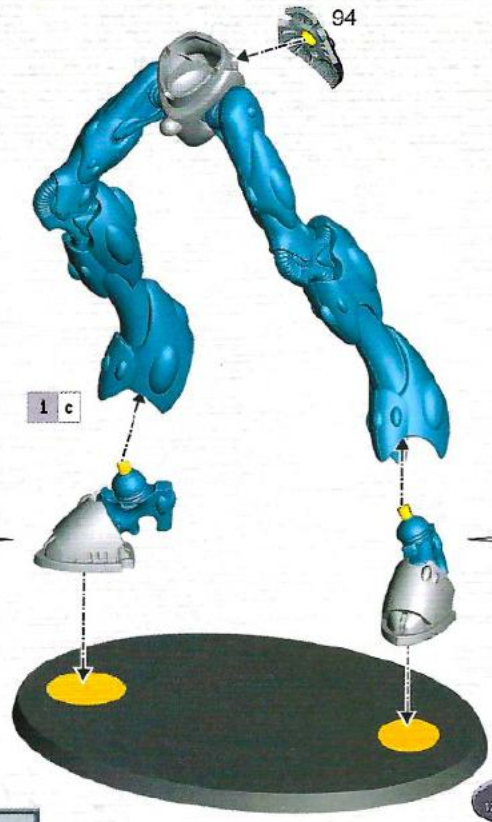
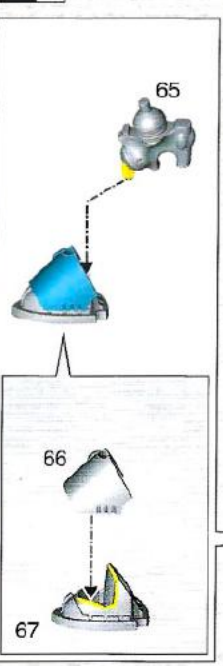

1 e

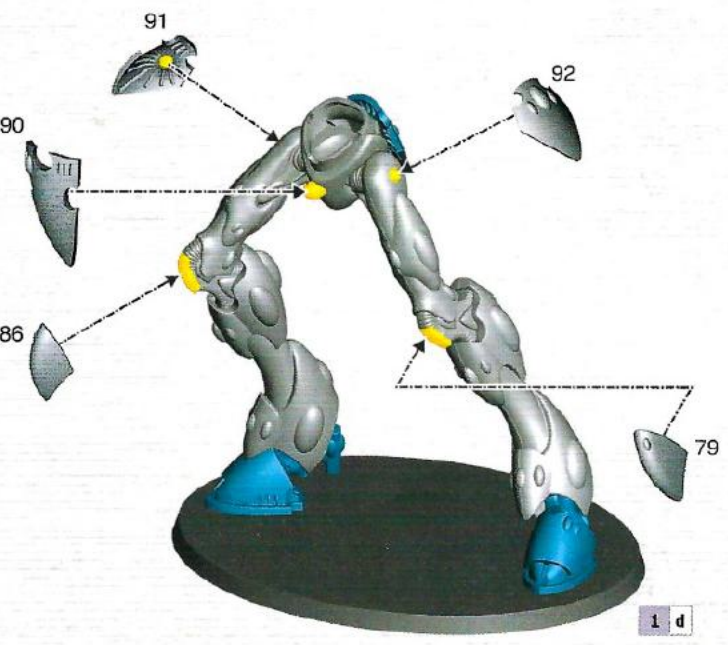

2 a

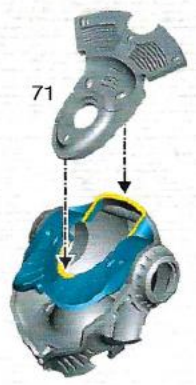
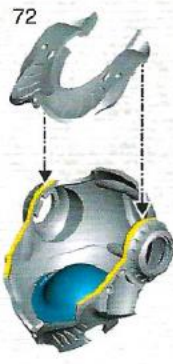
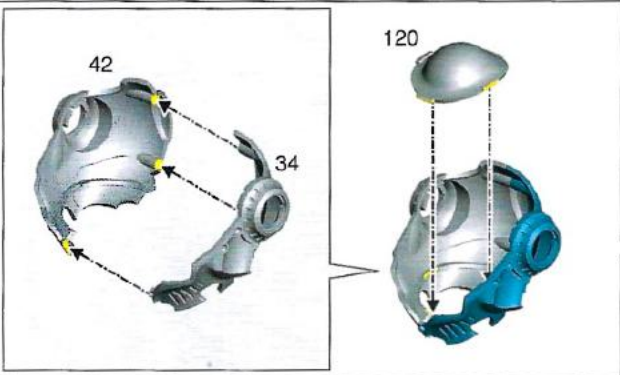

2 b

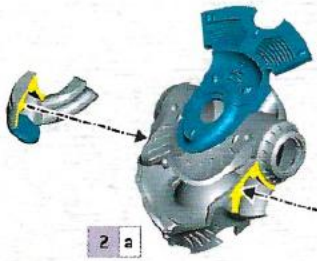
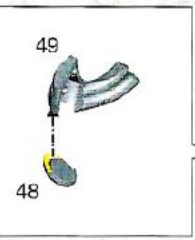

2 a

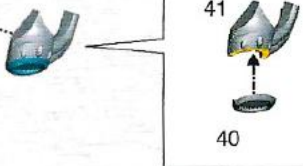

2 c

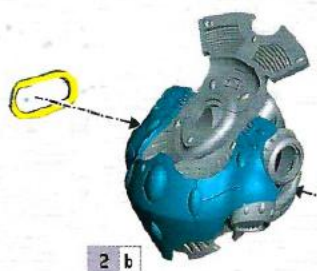
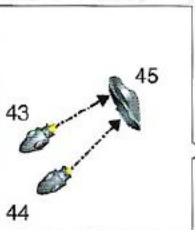

2 b

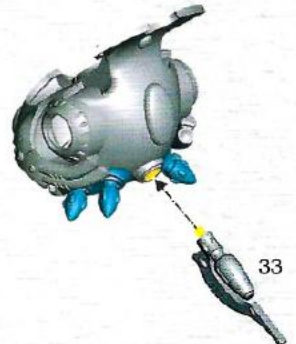
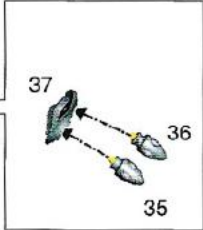

2 d

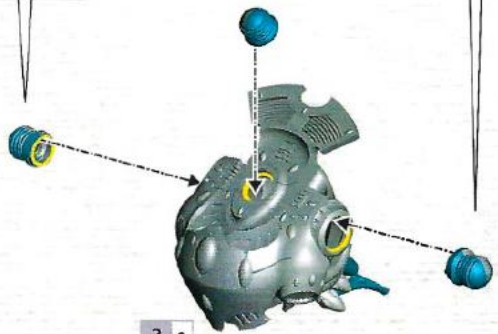
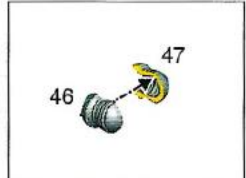
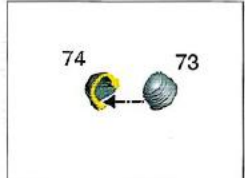
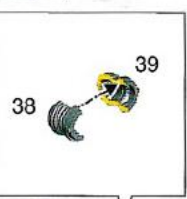

2 c

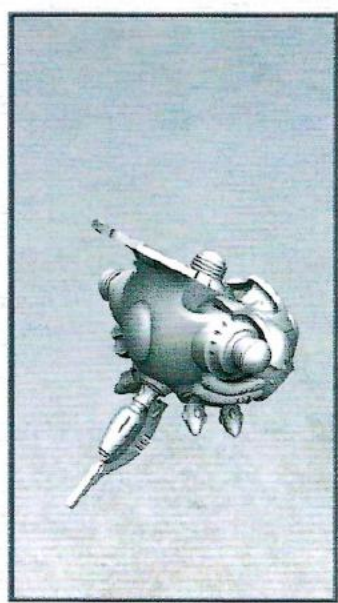

3 a

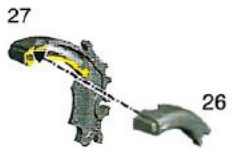

3 b



3 c

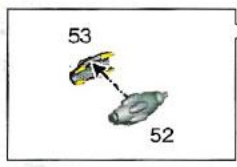
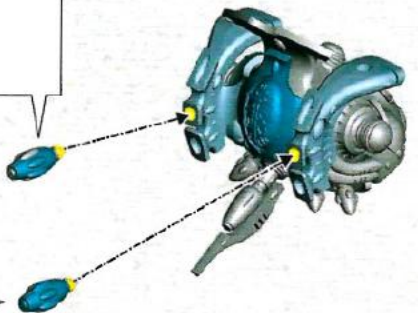
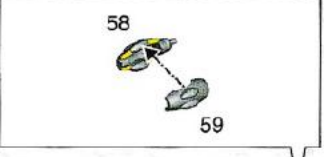
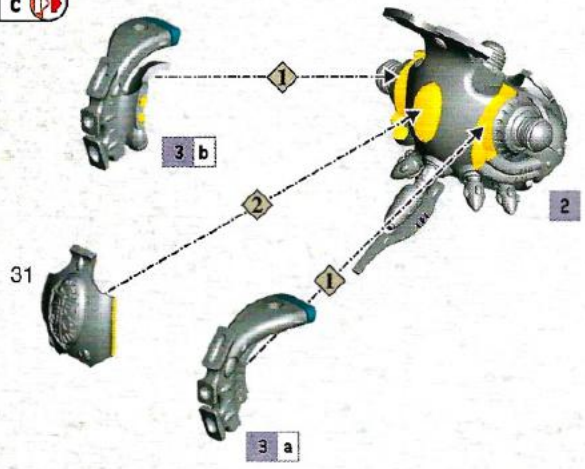

3 d

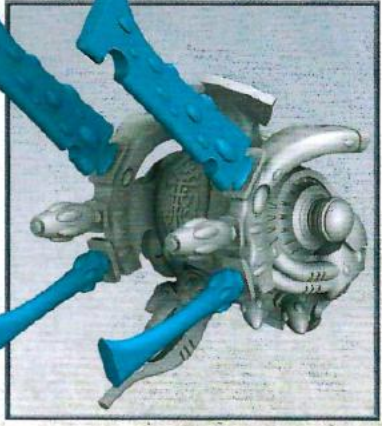
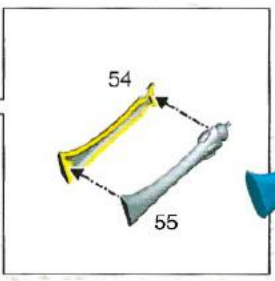
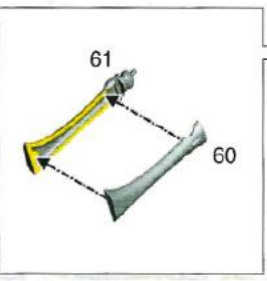
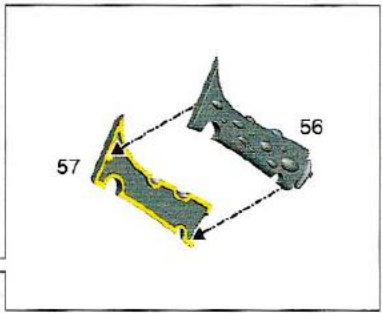
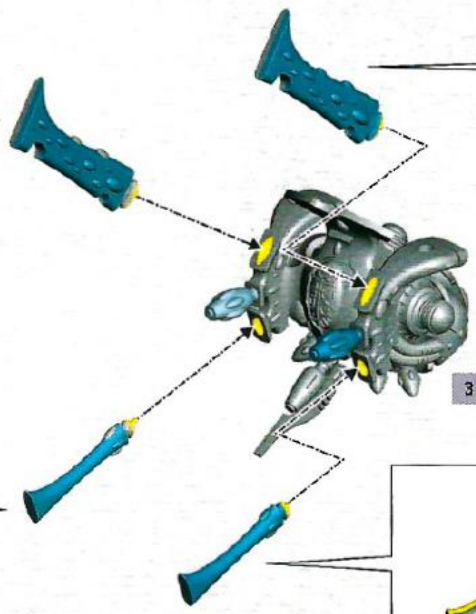
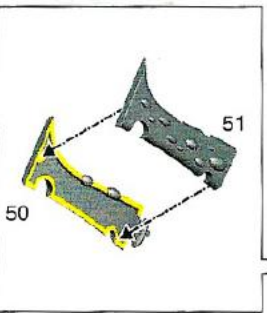

3 e

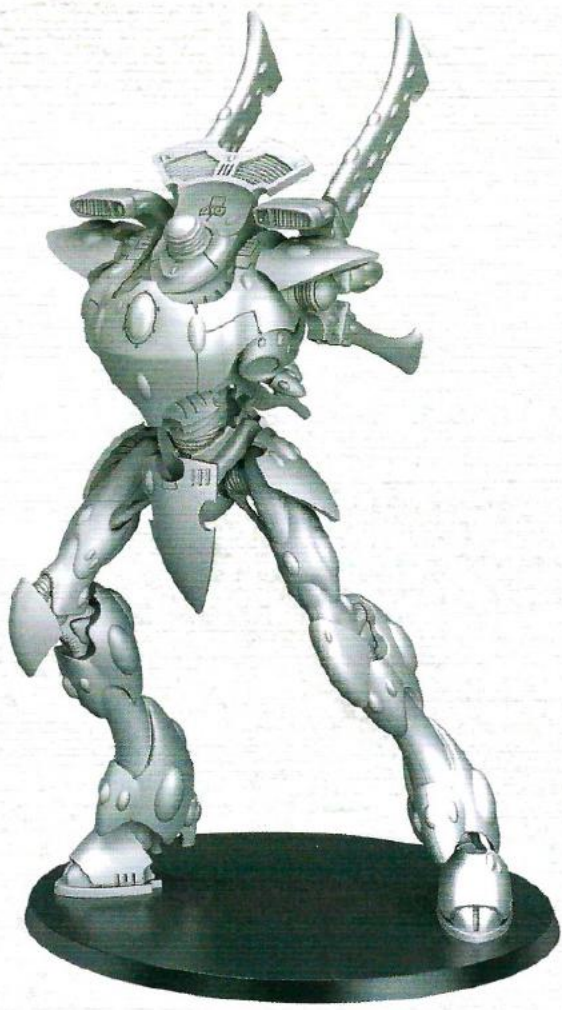
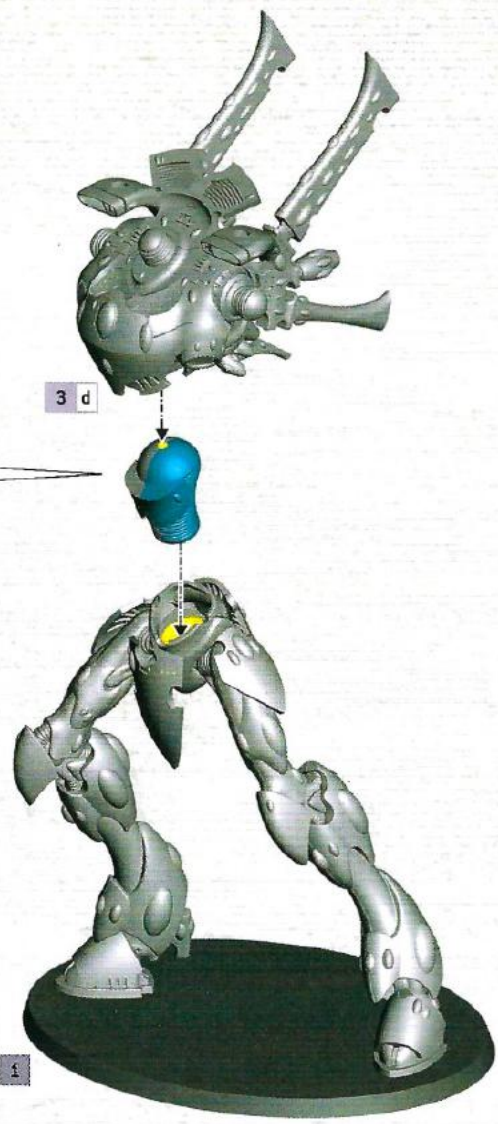
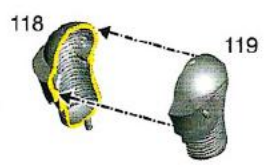

! • Choose the variant you want to build  
 • Choisissez la variante à assembler  
 • Elige qué versión quieres montar

• Wähle die Variante, die du bauen möchtest  
 • Scegli la variante che vuoi assemblare

• 組み立てバリエーションの選択  
 • 选择你喜欢的拼装方式



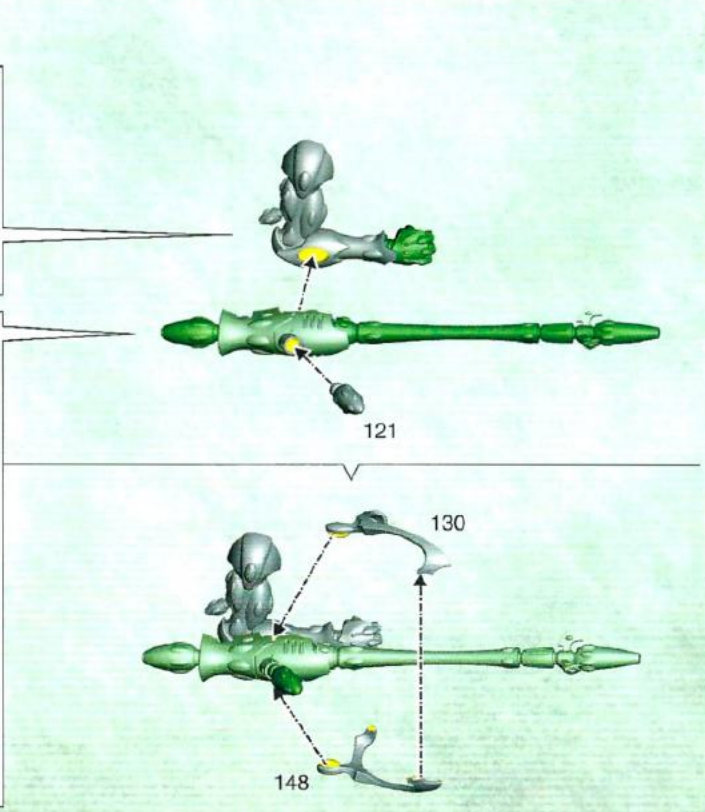
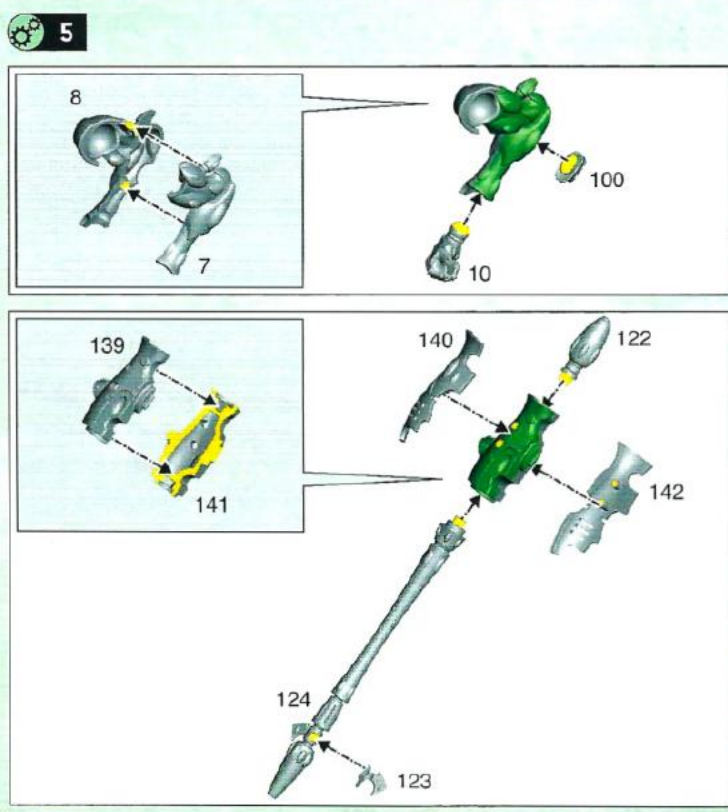
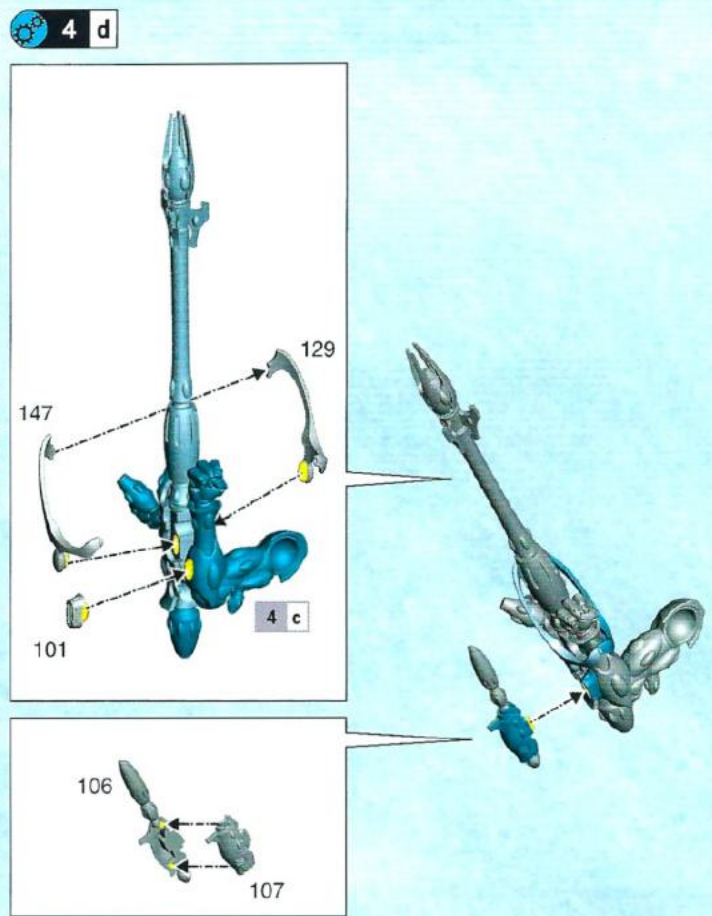
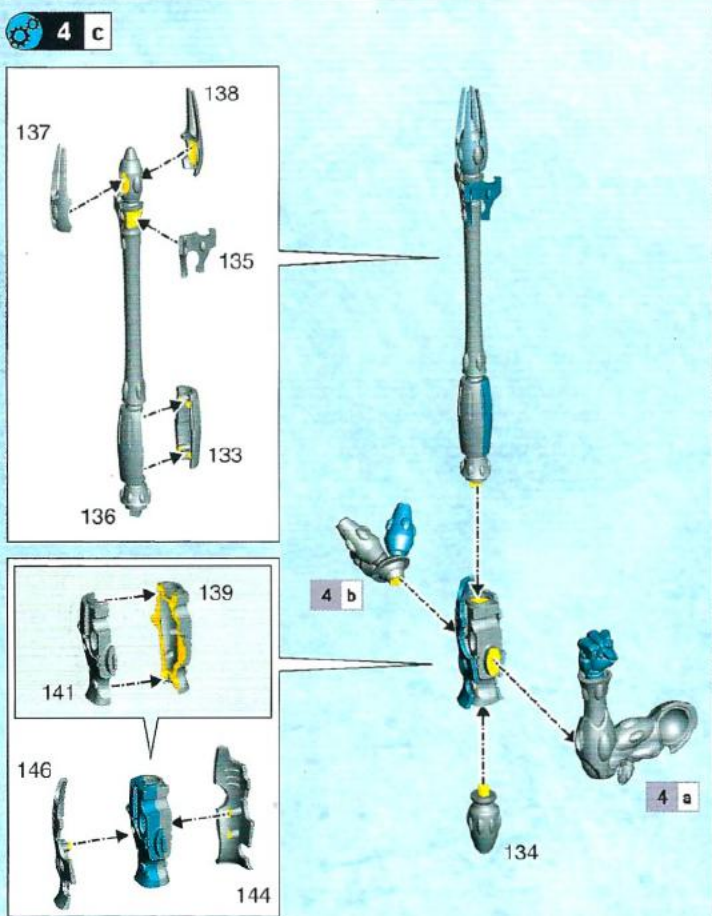
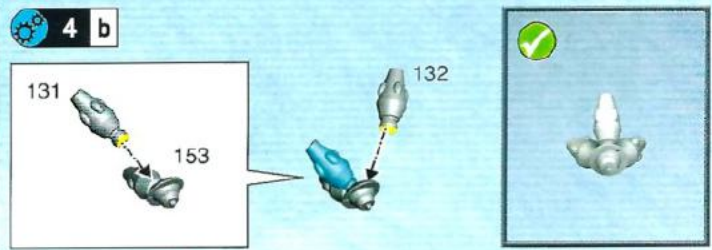
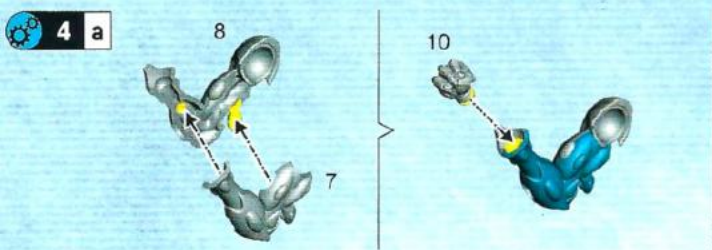

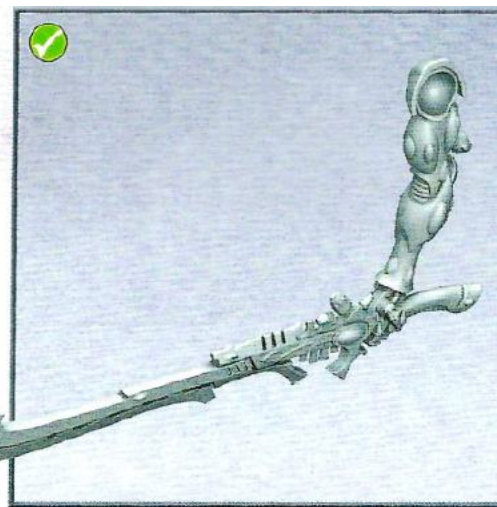
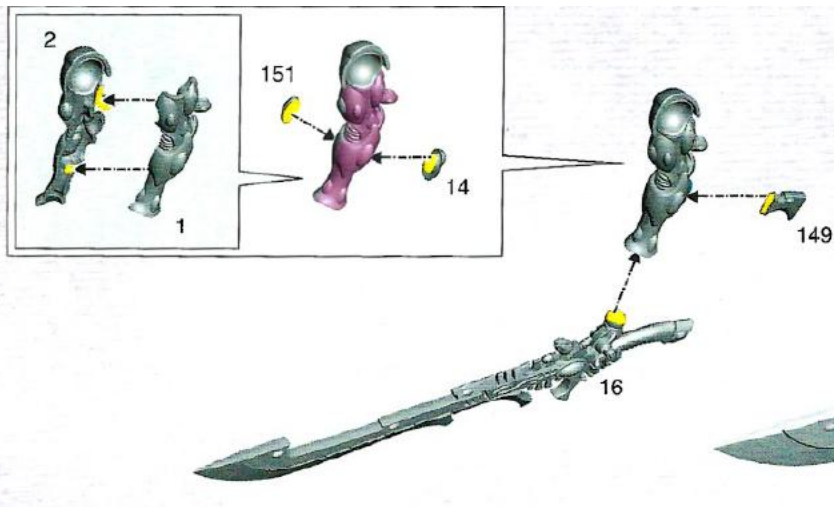

- Choose the variant you want to build
- Choisissez la variante à assembler
- Elige qué versión quieres montar
- Wähle die Variante, die du bauen möchtest
- Scegli la variante che vuoi assemblare
- 組み立てバリエーションの選択
- 选择你喜欢的拼装方式

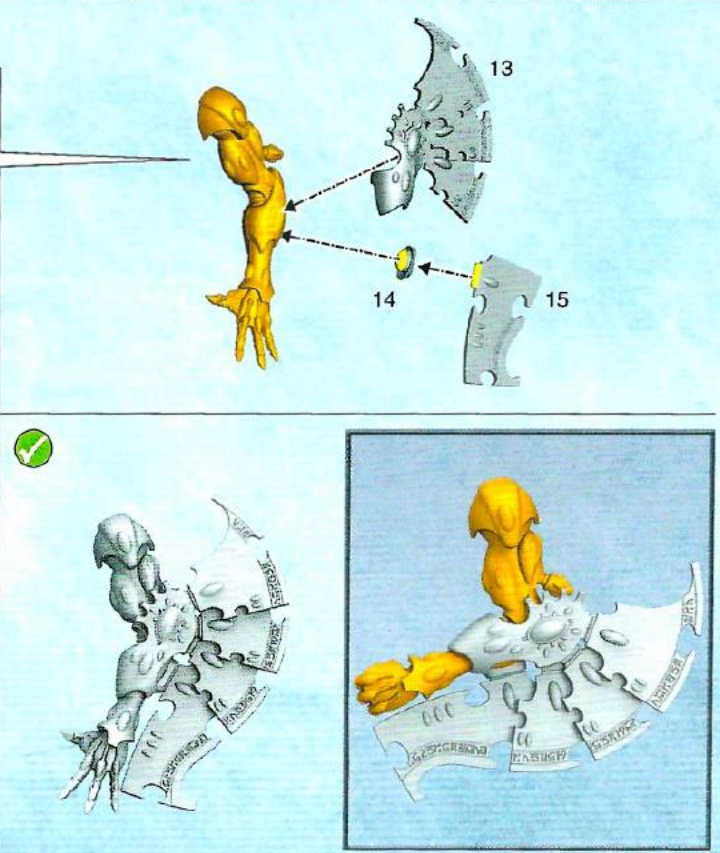
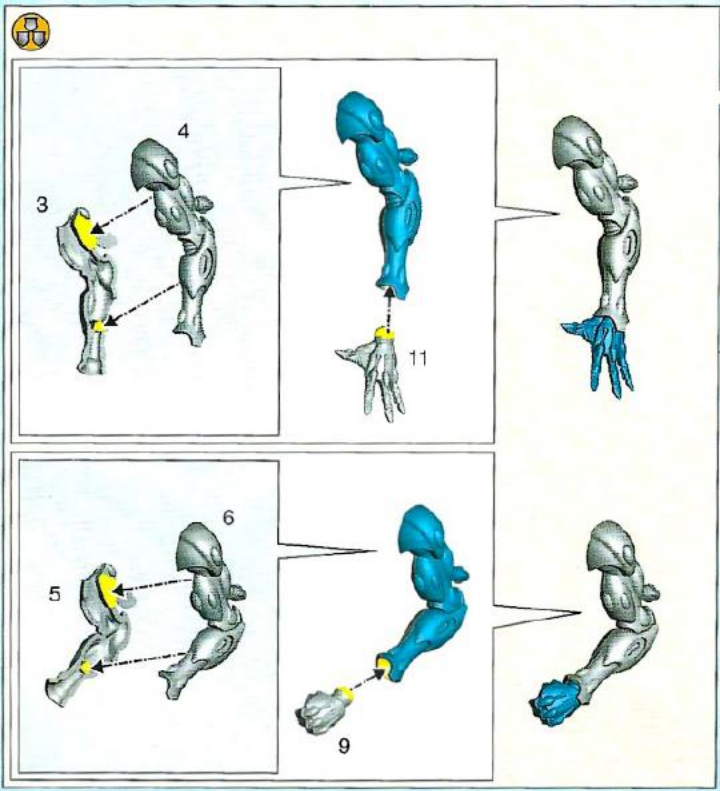
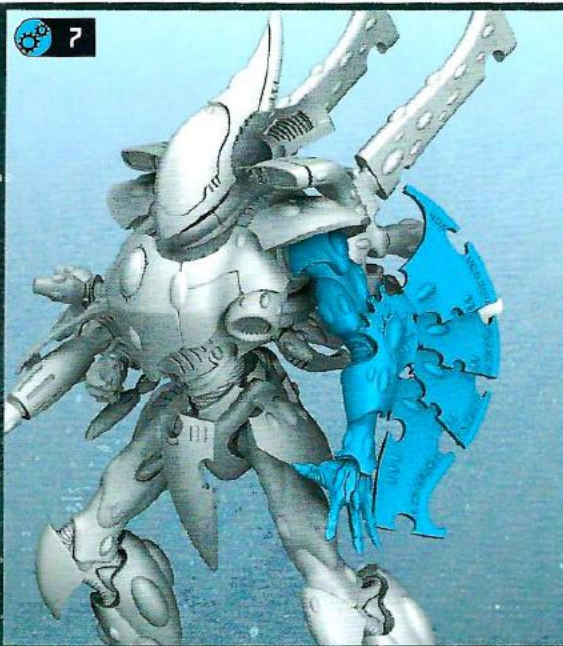

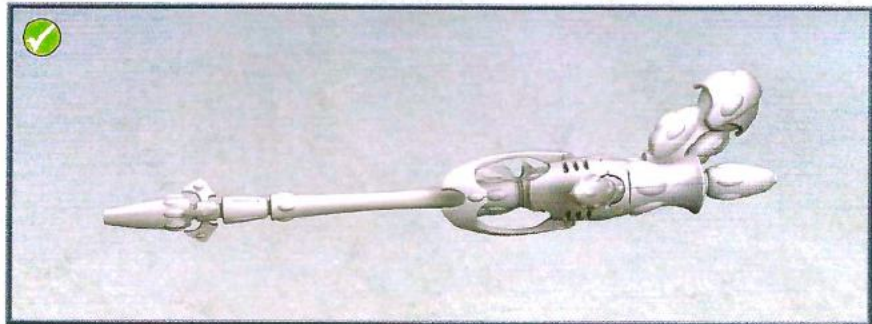
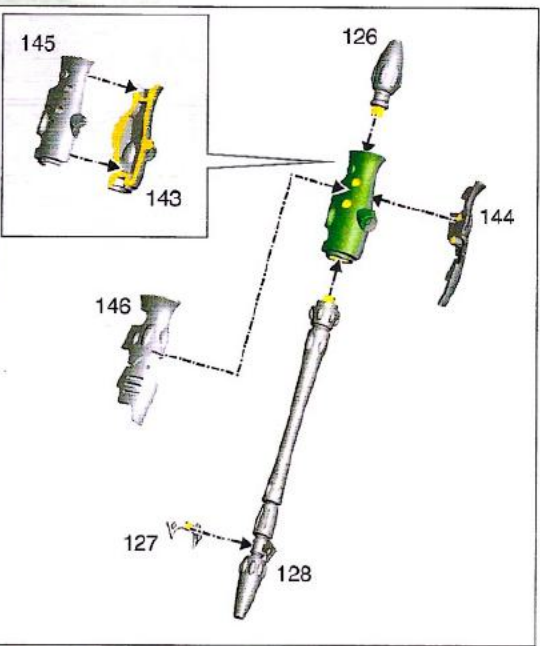
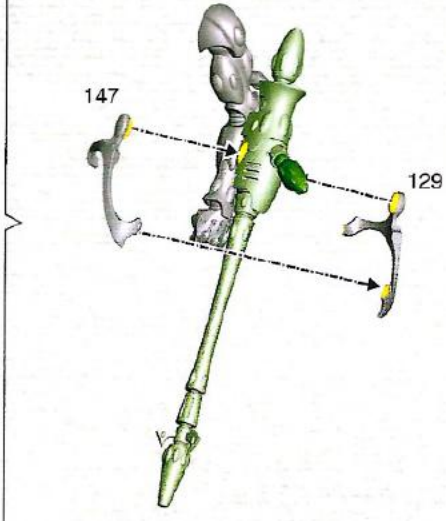
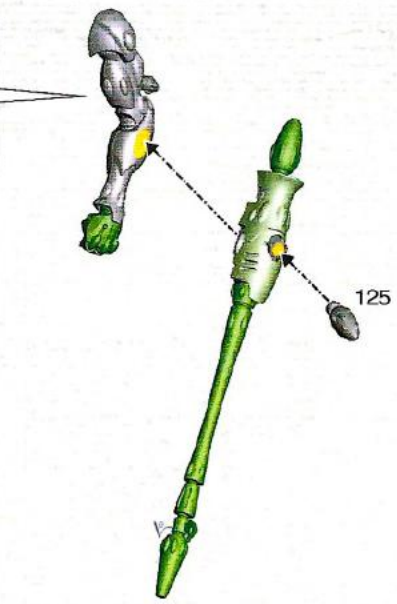
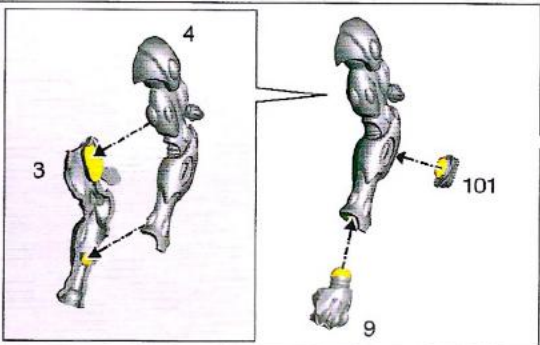

- 9**
- Choose the variant you want to build
  - Choisissez la variante à assembler
  - Elige qué versión quieres montar
  - Wähle die Variante, die du bauen möchtest
  - Scegli la variante che vuoi assemblare
  - 組み立てバリエーションの選択
  - 选择你喜欢的拼装方式

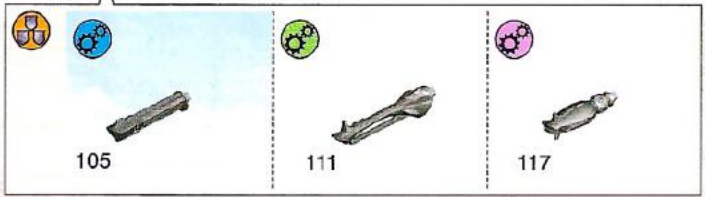
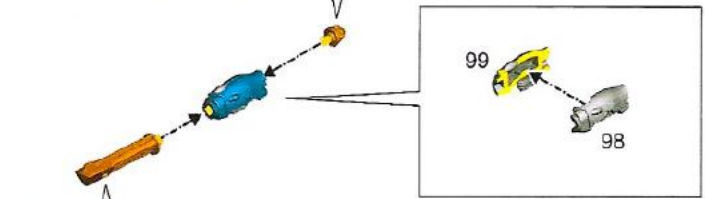
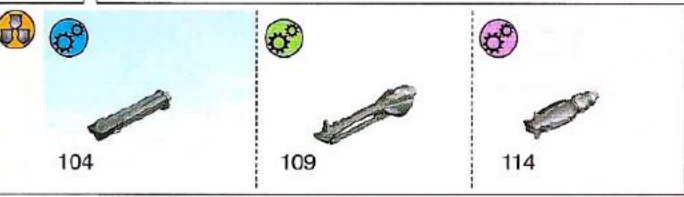
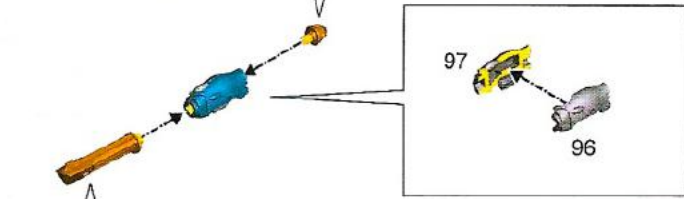
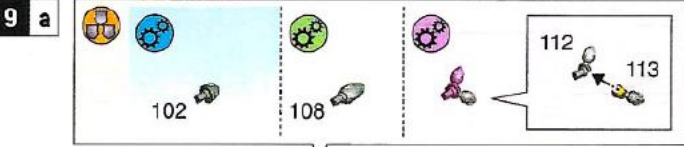
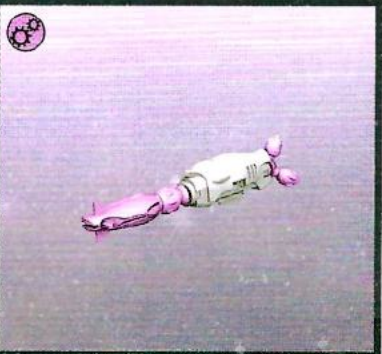
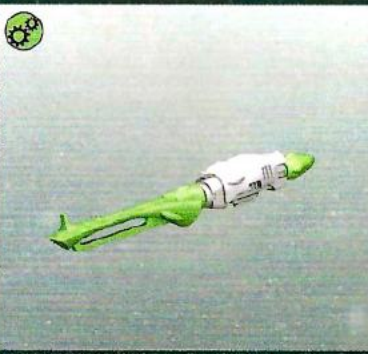
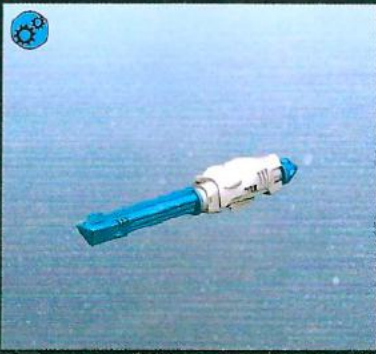

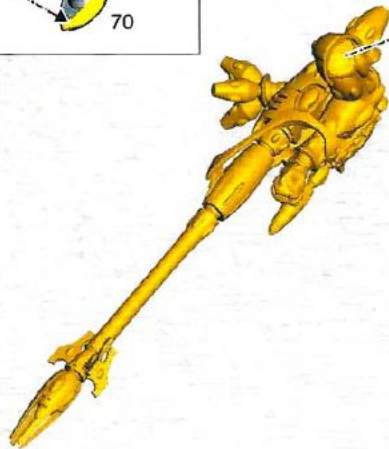
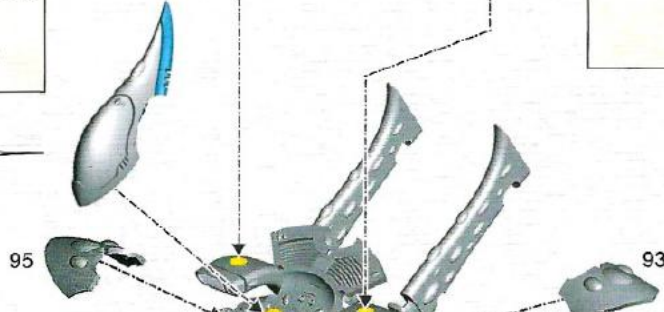
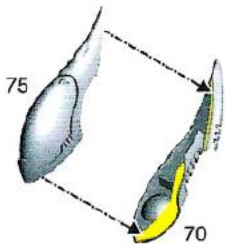
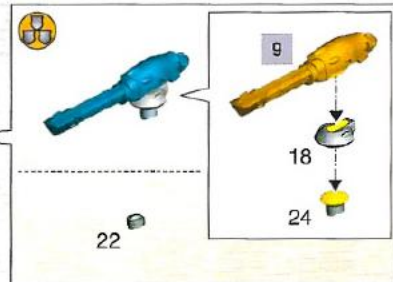
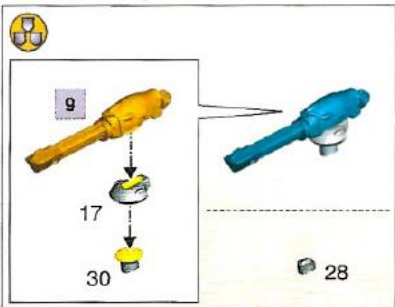

3

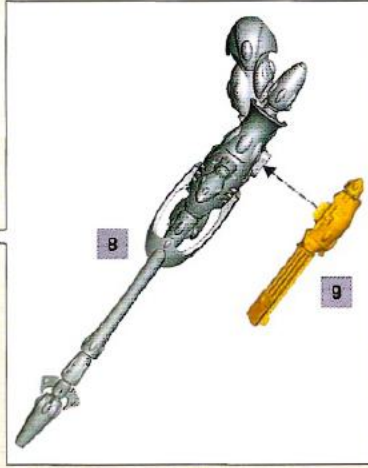
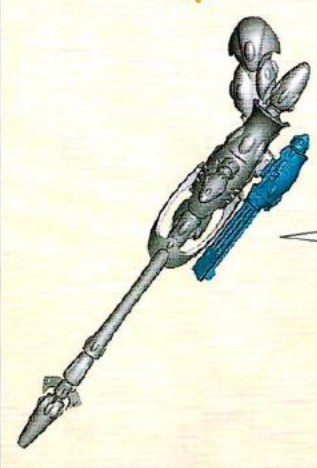
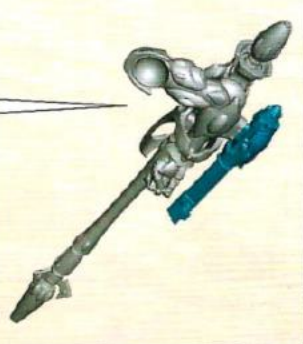
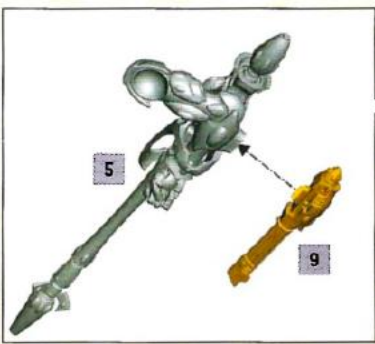
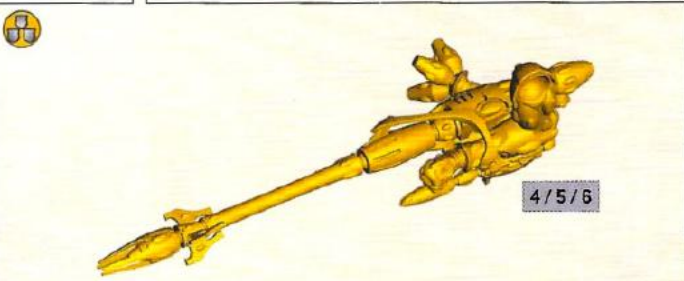



**ENG** Used alongside the core rules found on [warhammer40000.com](http://warhammer40000.com), the essential rules below will get your new unit on the battlefield. For the full rules for this unit, see the Codex relevant to your army.

**FRE** Utilisées avec les règles de base de [warhammer40000.com](http://warhammer40000.com), les règles essentielles ci-dessous vous permettront de jouer votre nouvelle unité sur le champ de bataille. Pour les règles complètes de cette unité, référez-vous au Codex correspondant à votre armée.

**ESP** Usadas junto a las reglas básicas que encontrarás en [warhammer40000.com](http://warhammer40000.com), las siguientes reglas esenciales pondrán tu nueva unidad en el campo de batalla. Para ver las reglas completas de esta unidad, consulta el Codex de tu ejército.

**GER** Wenn du die Regeln unten zusammen mit den Grundregeln auf [warhammer40000.com](http://warhammer40000.com) verwendest, kannst du deine Einheit direkt auf das Schlachtfeld führen. Die vollständigen Regeln für diese Einheit findest du im entsprechenden Codex für deine Armee.

**ITA** Usate assieme alle regole base che puoi trovare su [warhammer40000.com](http://warhammer40000.com), le regole essenziali in basso ti aiuteranno a portare sul campo di battaglia la tua nuova unità. Per le regole complete di questa unità, consulta il Codex corrispondente alla tua armata.

**日本** [warhammer40000.com](http://warhammer40000.com)に掲載されているコアルールとともに以下のユニット用基本ルールを使用することで、このユニットを戦場に配備することができます。このユニットの完全版ルールについては、このユニットが属するアーミーのコーデックスを参照してください。

**中文** 下方的基本规则需搭配 [warhammer40000.com](http://warhammer40000.com) 上的《核心规则》使用，可助您将新单位部署到战场上。有关该单位的完整规则，请参见与您的军队相关的《圣典》。

**WRAITHKNIGHT** | CHEVALIER FANTÔME | CABALLERO ESPECTRAL | PHANTMRITTER | SPETTROCAVALIERE | レイスナイト | 幽冥騎士

Wraithknight [12+	12"	3+	3+	8	8	22	5	9	3+
Wraithknight [6-11	10"	4+	4+	8	8	N/A	5	9	3+
Wraithknight [1-5	8"	5+	5+	8	8	N/A	5	9	3+

1	36"	D3	16	-4	D3+6
2	36"	6	6	0	1
3	24"	3	6	-1	2
4	36"	2	7	-3	2
5	48"	2D6	8	-3	3
6				-2	2
7			+6	-4	6
				-3	2

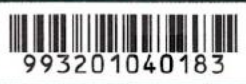
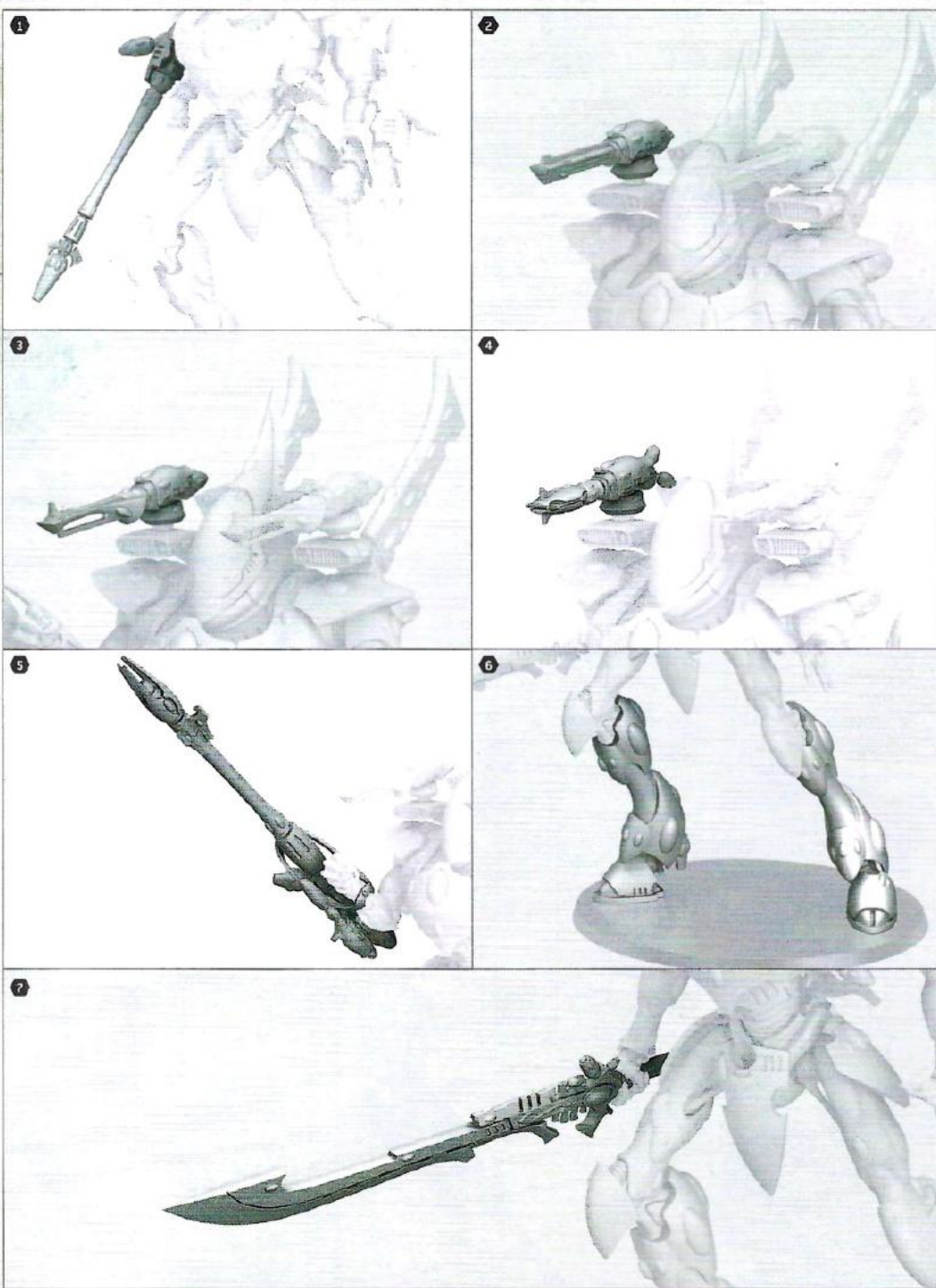

warhammer.com  
 Games Workshop Limited, Willow Road, Nottingham, NG7 2WS, UK  
 © Copyright Games Workshop Limited 2022.

