



Free Downloads of Build Instructions,
Assembly Booklets & How To Guides

BuildInstructions.com

WARHAMMER AGE OF SIGMAR



CANONNADE COGFORT

MÉCAFORT CANONNADE • FUERTE MECANIZADO CAÑONERO • BREITSEITE-ZAHNRADKASTELL
FORTE MECCANICO CANNONATA • キャノネード・コグフォート • 加农炮齿轮堡垒 • 포격 탑니요새



READ THIS FIRST • À LIRE EN PRIORITÉ • LEE ESTO PRIMERO • BITTE BEACHTE • LEGGI PRIMA QUESTO
最初にお読みください。• 请优先阅读 • 먼저 읽어주세요

BEFORE ASSEMBLING YOUR MINIATURES, PLEASE READ THROUGH THE INSTRUCTIONS BOOKLET CAREFULLY. A pair of plastic cutters are required to remove the plastic components from their frame. We advise using a mouldline scraping tool to clean up the parts. To assemble the model you will need glue suitable for plastic models. We recommend you follow all instructions and use the hobby accessories you purchase.

AVANT D'ASSEMBLER VOS FIGURINES, VEUILLEZ LIRE ATTENTIVEMENT LES INSTRUCTIONS DE CE LIVRET. Une pince coupante est requise pour retirer chaque élément de sa grappe de la matrice. Nous vous conseillons d'utiliser un ébarboir pour faire disparaître les lignes de moulage. Pour assembler votre figurine, vous aurez besoin d'une colle spéciale pour le plastique. Nous vous recommandons de suivre les instructions et de respecter les mises en garde fournies avec les outils que vous achetez.

BEFORE ASSEMBLING YOUR MINIATURES, PLEASE READ THROUGH THE INSTRUCTIONS BOOKLET CAREFULLY. A pair of plastic cutters are required to remove the plastic components from their frame. We advise using a mouldline scraping tool to clean up the parts. To assemble the model you will need glue suitable for plastic models. We recommend you follow all instructions and use the hobby accessories you purchase.

BEFORE ASSEMBLING YOUR MINIATURES, PLEASE READ THROUGH THE INSTRUCTIONS BOOKLET CAREFULLY. A pair of plastic cutters are required to remove the plastic components from their frame. We advise using a mouldline scraping tool to clean up the parts. To assemble the model you will need glue suitable for plastic models. We recommend you follow all instructions and use the hobby accessories you purchase.

ITA PRIMA DI ASSEMBLARE LE MINIATURE LEGGI CON ATTENZIONE LE INSTRUZIONI IN QUESTO LIBRETTO. Per rimuovere dallo sprue i componenti di plastica di questo kit è necessario un paio di tronchesine per plastica. Consigliamo l'utilizzo di un attrezzo per ripulire. Per assemblare il modello hai bisogno di colla idonea ai modelli di plastica. Consigliamo di seguire tutte le istruzioni e le avvertenze che accompagnano gli strumenti hobbistici acquistati.

JAP ミニチュアを組み立てる前に、この冊子の説明をよくお読みください。このキットのプラスチック部品をフレームから取り外すには、プラスチック用カッターが必要です。パーツの表面を整えるには、モールドライン・スクレイピングツールを使用することをお勧めします。組み立てにはプラスチックミニチュア用の接着剤が必要です。購入したホビー用品に記載されているすべての指示と警告に従うことをお勧めします。

CHI 在组装您的微缩模型之前，请仔细阅读本手册中的说明。您需要塑料剪钳能从框架中取出板件中的塑料部件。我们建议使用合模线刮刀来清理零件。要组装您的模型，您还需要适合塑料模型的胶水。我们建议您遵循模型所附的所有说明和警告。

KOR 미니어처 조립 전 이 가이드의 설명을 상세히 읽어주세요. 본 키트의 플라스틱 부품을 스프루에서 떼어내려면 플라스틱용 니퍼가 필요합니다. 부품의 표면을 정리하기 위해서는 몰드라인 리무버를 사용할 것을 권장합니다. 모델 조립용 플라스틱 모델에 적합한 접착제가 필요합니다. 구매하는 취미용 부속품의 모델 설명 및 주의 사항을 따를 것을 권장합니다.

CHOOSE THE VARIANT YOU WANT TO BUILD • CHOISISSEZ LA VARIANTE À ASSEMBLER • ELIGE QUÉ VERSIÓN QUIERES MONTAR
 WÄHLE DIE VARIANTE, DIE DU BAUEN MÖCHTEST • SCEGLI LA VARIANTE CHE VUOI ASSEMBLARE • 組み立てバリエーションの選択
 选择你喜欢的拼装方式 • 조립 옵션을 선택하세요

1-2; 5-15 CANNONADE COGFORT

MÉCAFORT CANONNADE
 FUERTE MECANIZADO CAÑONERO
 BREITSEITE-ZAHNRADKASTELL
 FORTE MECCANICO CANNONATA
 キャノネード・コグフォート
 加农炮齿轮堡垒
 포격 톱니요새



3-4; 5-15 CONQUEROR COGFORT

MÉCAFORT CONQUÉRANT
 FUERTE MECANIZADO CONQUISTADOR
 EROBERER-ZAHNRADKASTELL
 FORTE MECCANICO CONQUISTATORE
 コンカラー・コグフォート
 征服者齿轮堡垒
 정복자 톱니요새



EXPLANATION OF SYMBOLS • EXPLICATION DES SYMBOLES • EXPLICACIÓN DE SÍMBOLOS • ERLÄUTERUNG DER SYMBOLE
 LEGENDA DEI SIMBOLI • 아이콘解説 • 符号说明 • 기호 설명

- Attention - Take care
- Instructions Spéciales - Faites attention
- Atención - Cuidado
- Achtung - Bitte beachten
- Attenzione - Prestare attenzione
- 注意 - ここは注意が必要だ
- 请注意 - 请小心
- 주의 - 주의가 필요합니다

- Build X - Repeat this stage the amount shown
- Assembler X - Répétez cette étape autant de fois qu'indiqué
- Montar X - Repite este paso X veces
- X bauen - Schritt die angegebene Anzahl wiederholen
- Assembla X - Ripeti questo passo il numero di volte indicato
- X個組み立て - この行程を回数ぶん繰り返す
- 拼装 X 个 - 重复该步骤, 数量如说明所示
- X개 조립 - 표시된 개수만큼 이 단계를 반복하세요

- Variant - Choose the build wanted
- Variante - Choisissez l'assemblage voulu
- Sin pegamento - No pegues estas piezas
- Variante - Wähle die Variante, die du bauen möchtest
- Variante - Scegli l'opzione desiderata
- バリエーション - 組み立てるバリエーションを選択す
- 可选方案 - 选择您喜欢的拼装方式
- 옵션 - 원하는 형태로 조립하세요

- Reversible - Choose the side to use
- Réversible - Choisissez le côté à utiliser
- Reversible - Elige qué lado usar
- Umkehrbar - Wähle die Seite, die du verwendest
- A doppia faccia - Scegli il lato da usare
- 两用可能 - どちらの側に使用するか選択する
- 可調整拼装方向 - 选择使用哪一侧进行拼装
- 양면 - 사용할 면을 선택하세요

- Interchangeable Parts - More than one part to choose from
- Éléments interchangeables - Plusieurs pièces disponibles
- Partes intercambiables - Más de una pieza entre las que elegir
- Austauschbare Teile - Mehr als ein Teil zur Auswahl
- Componenti intercambiabili - Diversi componenti tra cui scegliere
- 組み換え可能な部品 - 複数の部品から選択する
- 可互换零件 - 多个组件可供选择
- 선택 가능 부품 - 여러 개 부품 중 선택하세요

- No Glue - Do not glue together
- Sans Colle - Ne pas coller ensemble
- Sin pegamento - No pegues estas piezas
- Kein Klebstoff - Nicht zusammenkleben
- Niente colla - Non incollare
- 接着しない - この部分は接着しないこと
- 勿用胶水 - 请勿用胶水粘合
- 접착 금지 - 서로 접착하지 마세요

- Sequence - Build in order shown
- Séquence - Assemblez dans l'ordre indiqué
- Secuencia - Monta en el orden mostrado
- Reihenfolge - In angegebener Abfolge bauen
- Ordine - Assembla nell'ordine mostrato
- 手順 - この順番で組み立てる
- 步骤顺序 - 按所示顺序进行拼装
- 순서 - 표시된 순서대로 조립하세요

- Paint - Paint before final assembly
- Peindre - Peignez avant assemblage final
- Pintar - Pinta antes de montaje definitivo
- Malen - Vor Zusammenbau bemalen
- Dipingi - Dipingi prima dell'assemblaggio finale
- ペイント - 組み立て前にペイントしよう
- 涂装 - 在最终组装前进行涂装
- 도색 - 최종 조립 전에 도색하세요

- Complete - Stage or model finished
- Terminé - Étape ou figurine terminée
- Terminado - Fase o miniatura terminadas
- Fertig - Schritt oder Modell abgeschlossen
- Finito - Passo o modello terminato
- 完成 - この段階、もしくはこのミニチュアが完了した
- 完成 - 步骤或模型已完成
- 완성 - 단계 또는 모델이 완성되었습니다

1 a



1 b



1 c



C1



B4



1 d 2

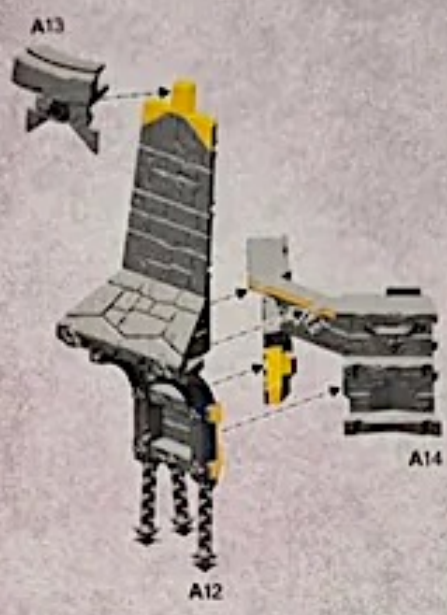

1 e



1 f

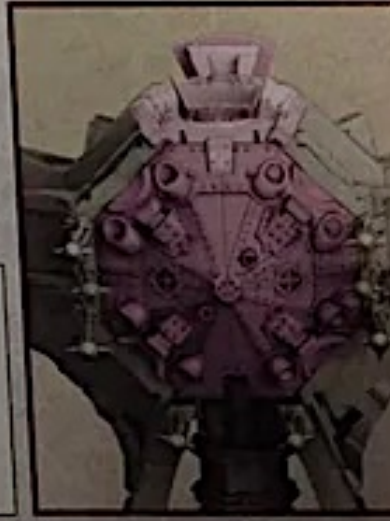
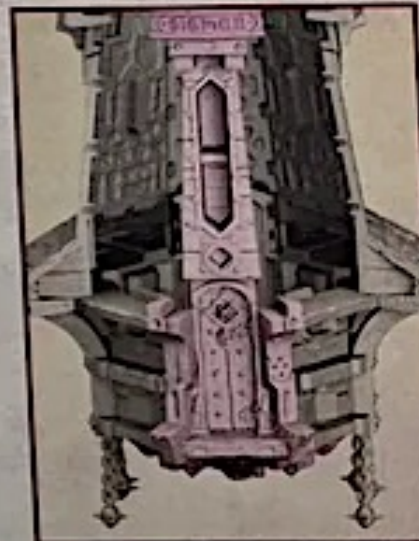
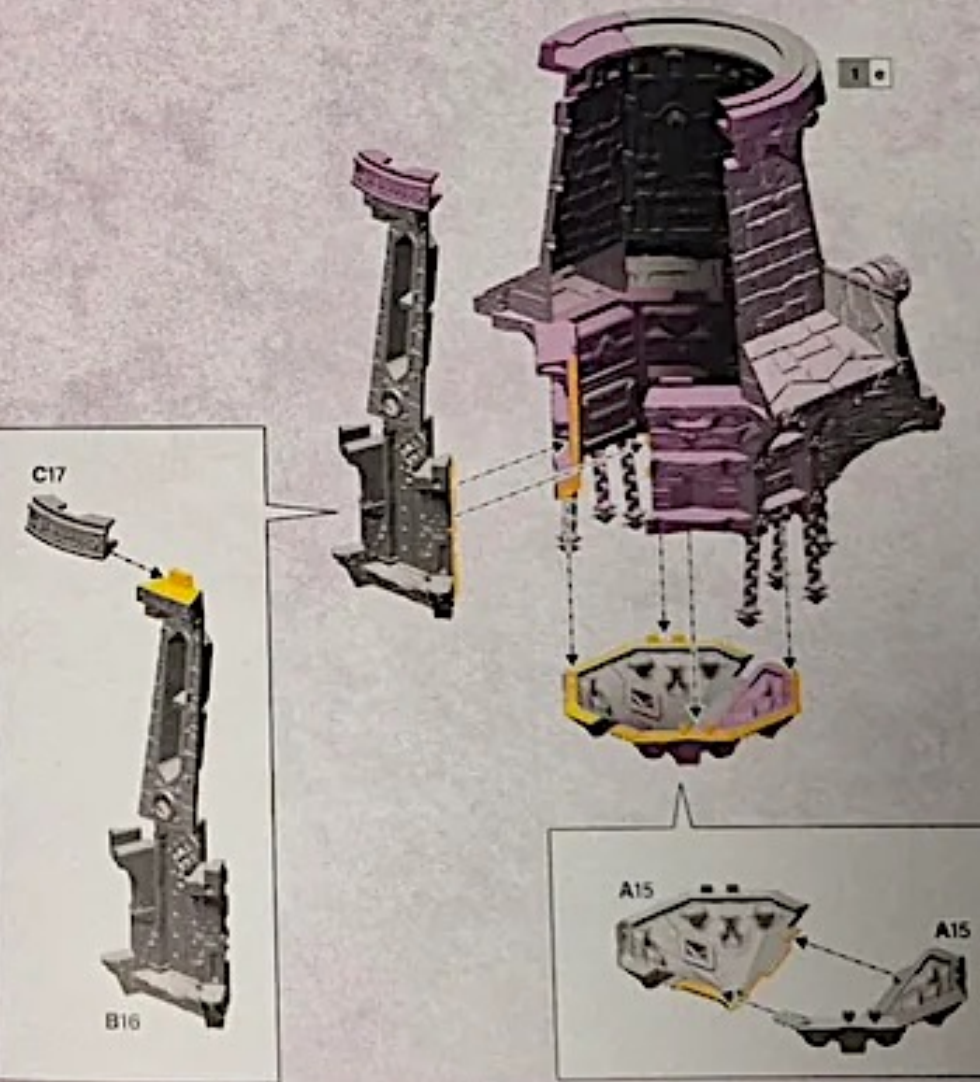

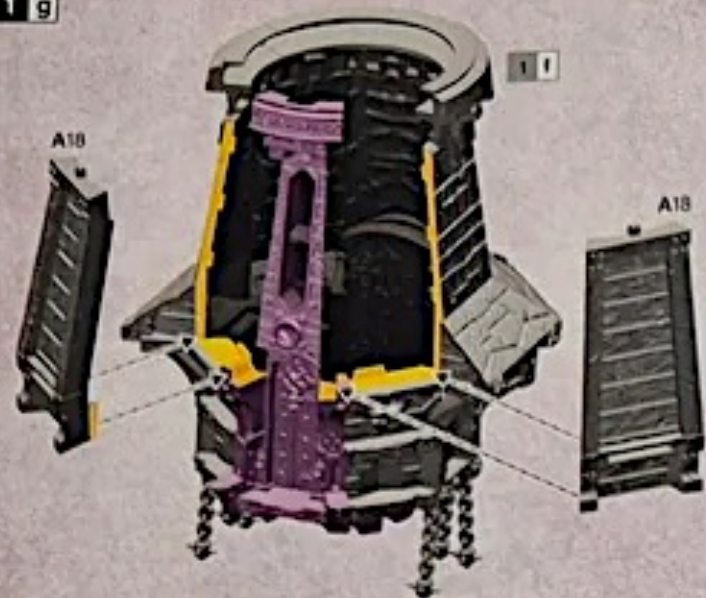
1 g

A19

A19

**1 h****1 g**

C35

B34

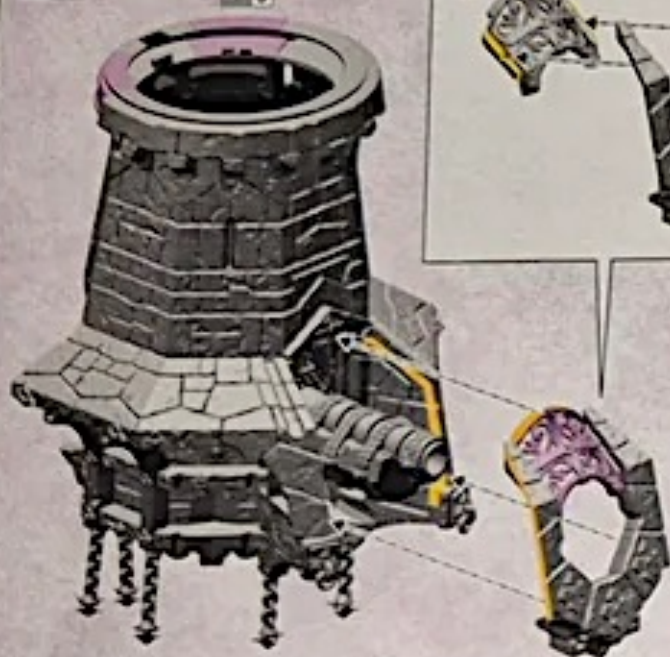
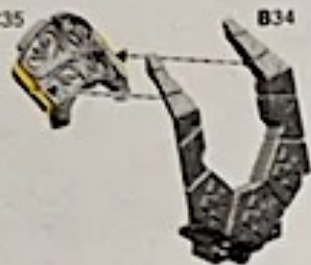

B37



B36

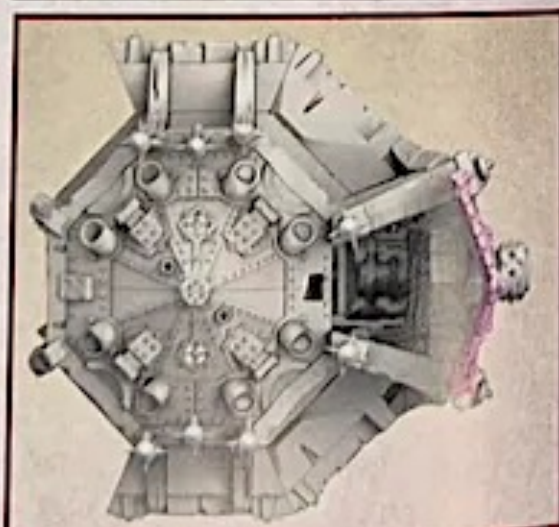

2 a

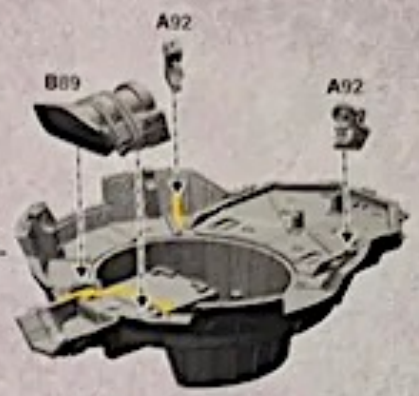
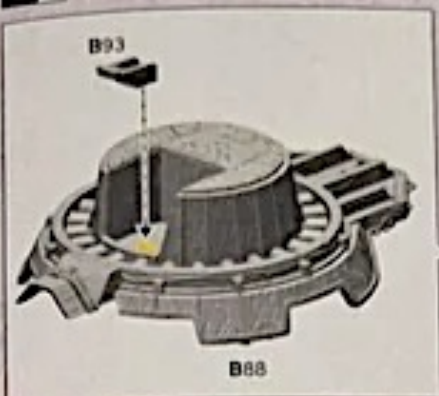

2 b

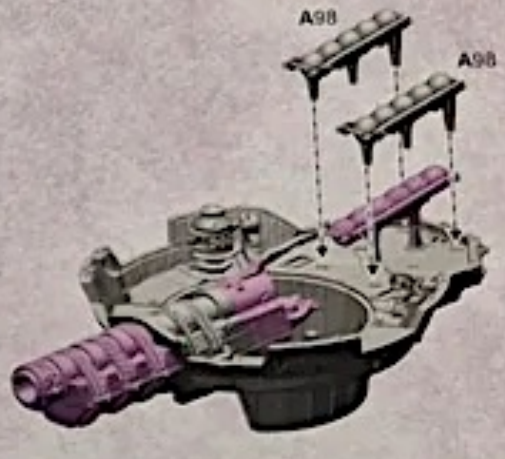
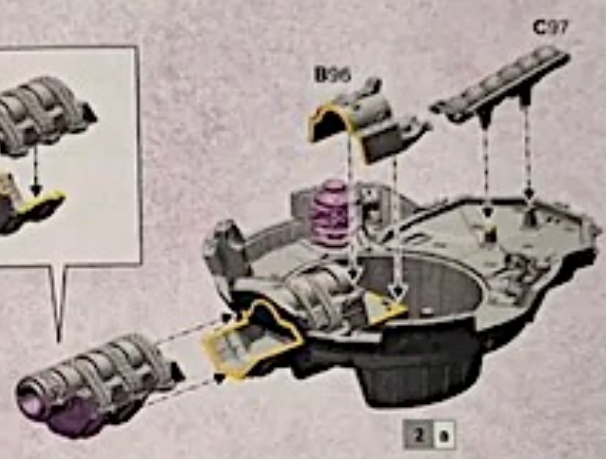

2 c

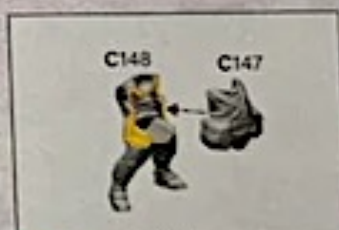
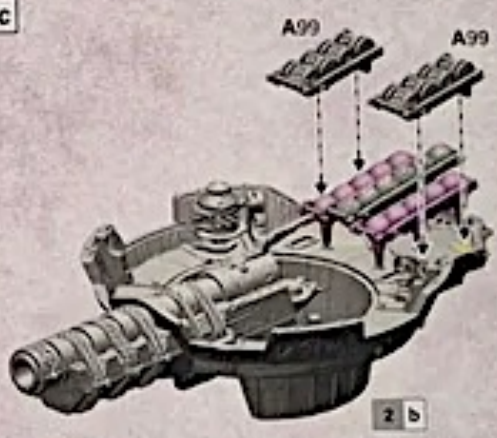

2 d

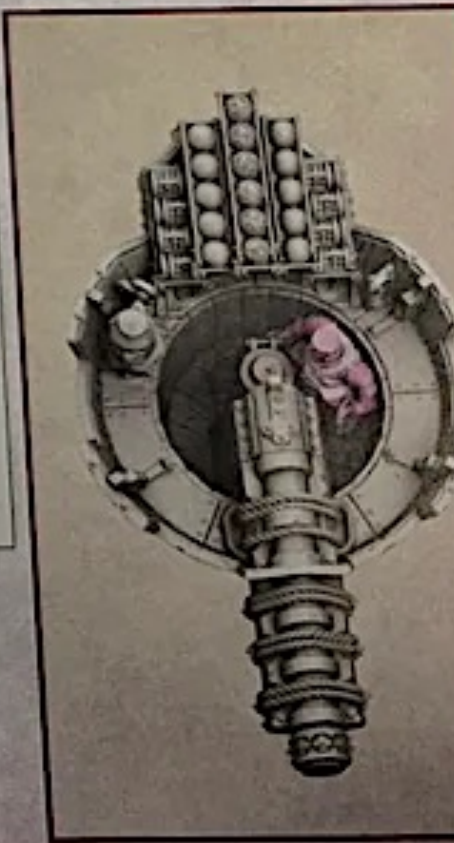
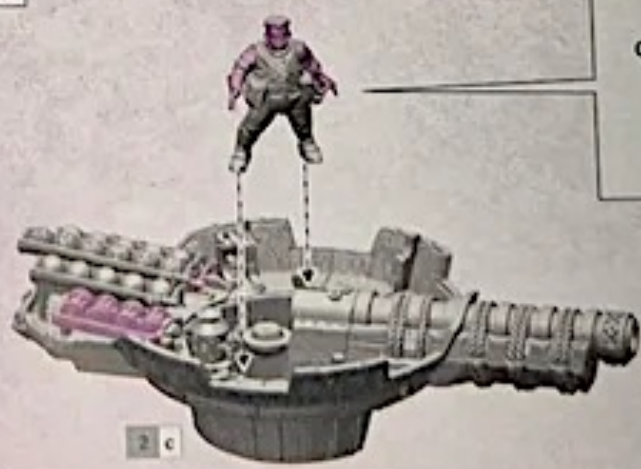

2 e

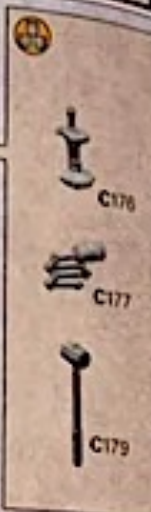

2 f

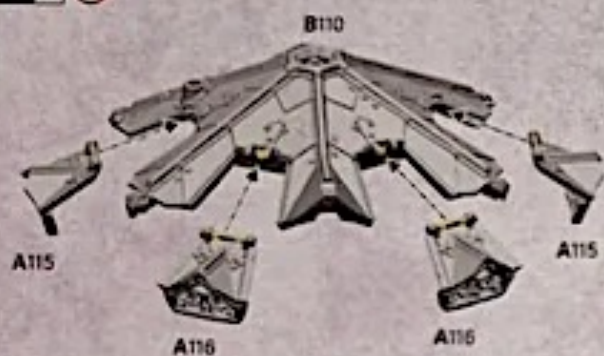

2 g

2 f



✓



3 a



3 b



- 3 c**
- Choose the variant you want to build
 - Choisissez la variante à assembler
 - Elige qual versão queres montar
 - Wähle die Variante, die du bauen möchtest
 - Scegli la variante che vuoi assemblare
 - 組み立てバリエーションの選択
 - 選擇你喜愛的組裝方式
 - 조립 옵션을 선택하세요

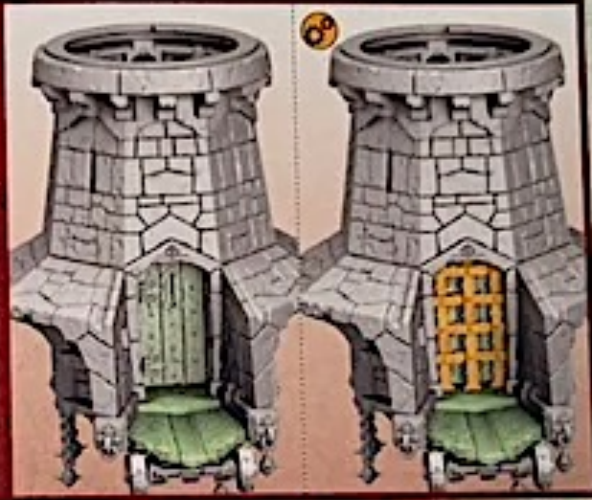

3 d



3 c

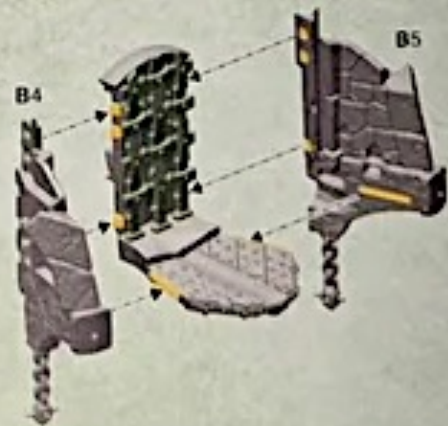
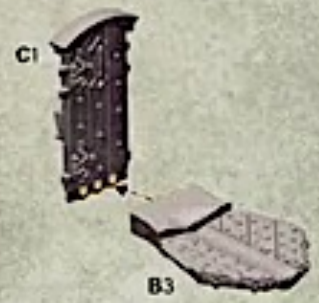

3 c 2



3 f

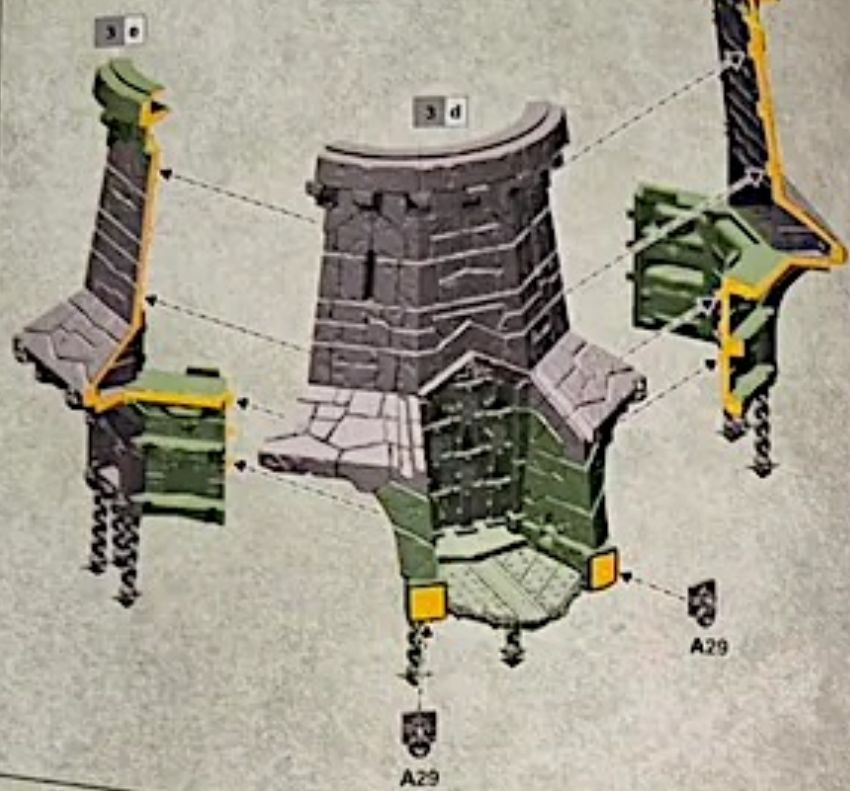

3 g

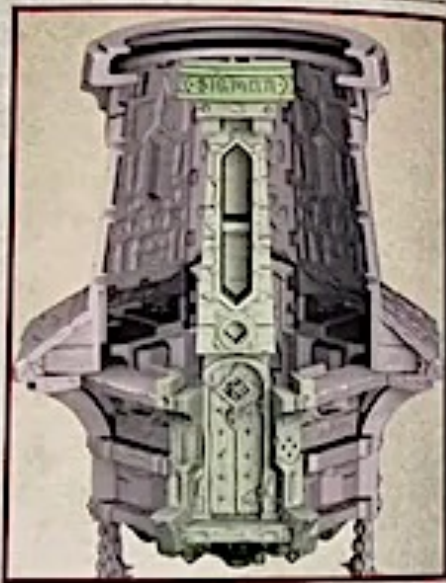
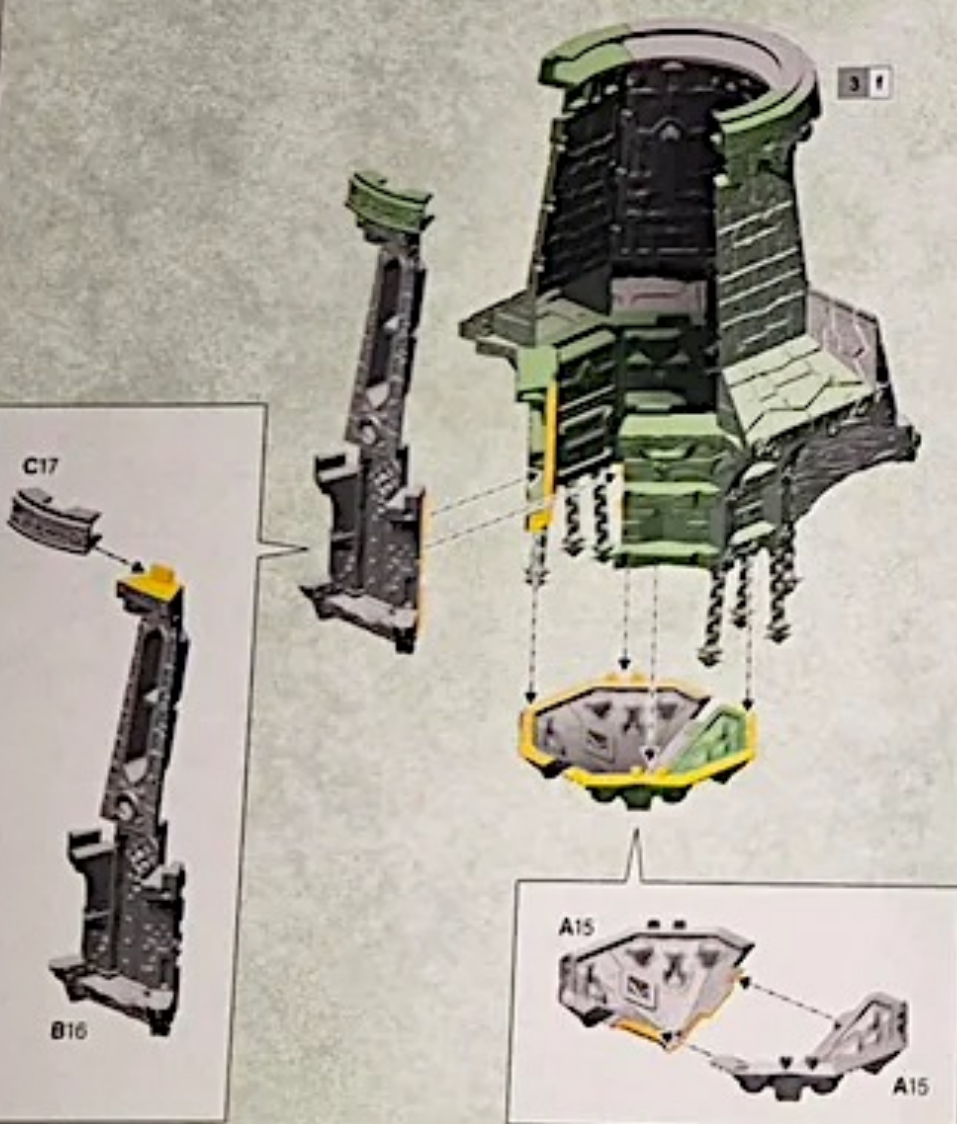

3 h

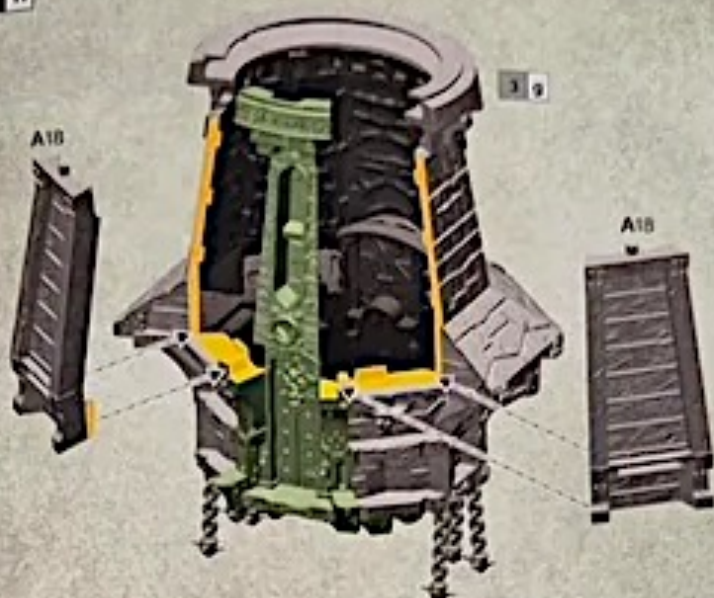

3 i

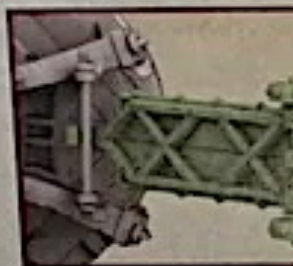
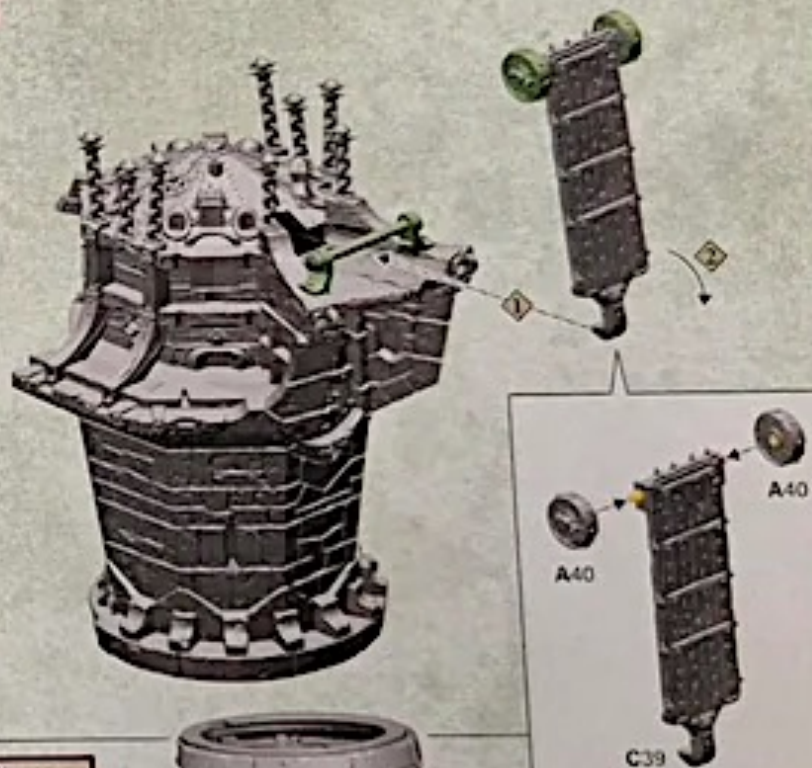

38

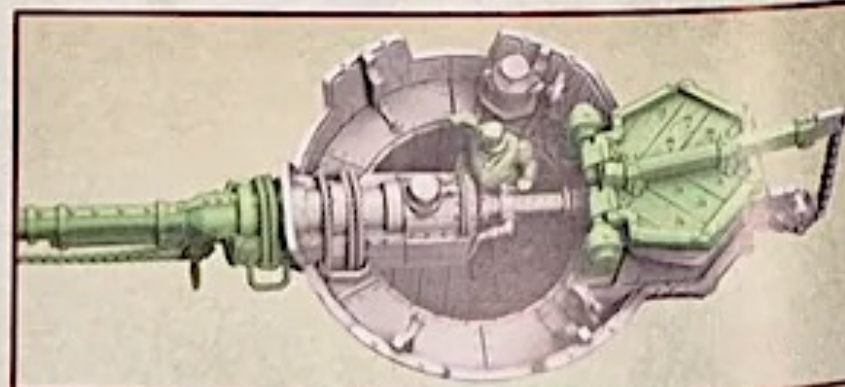
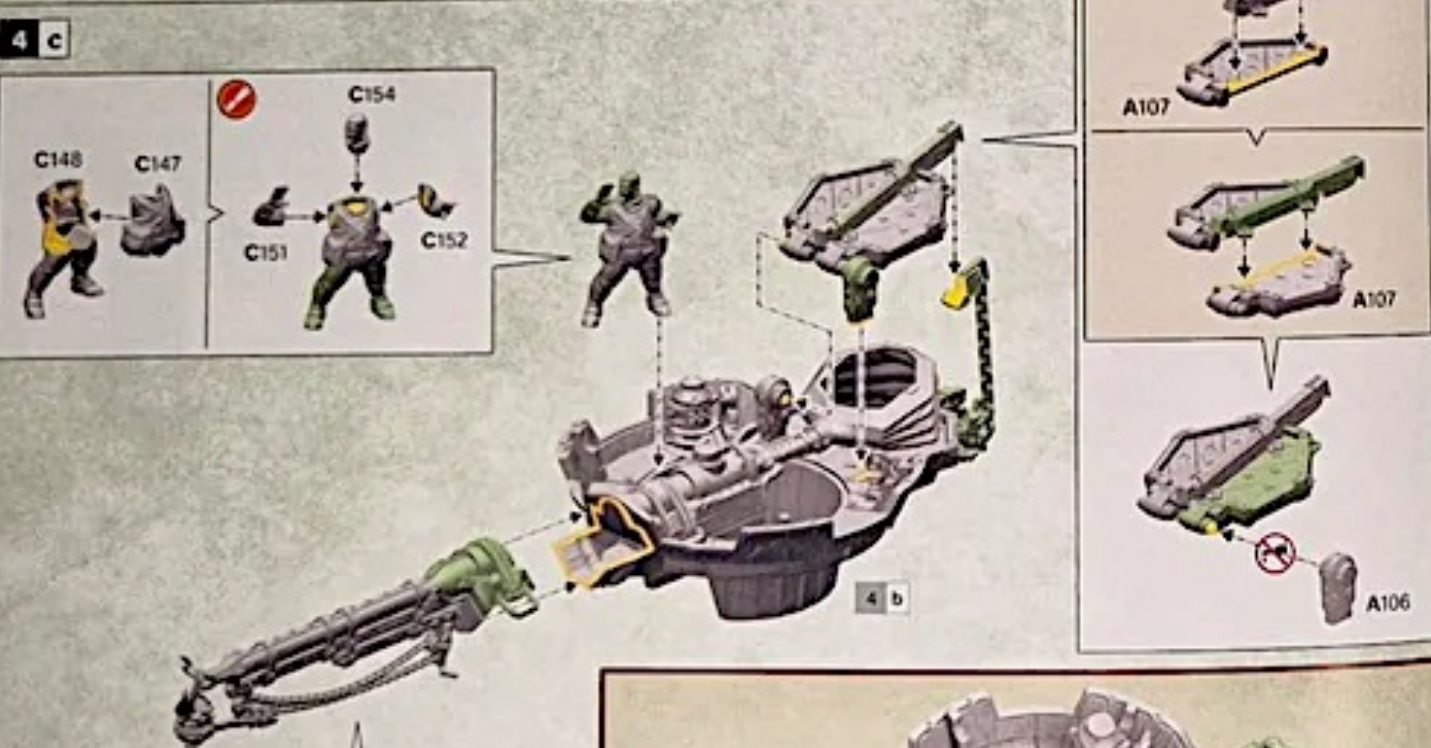
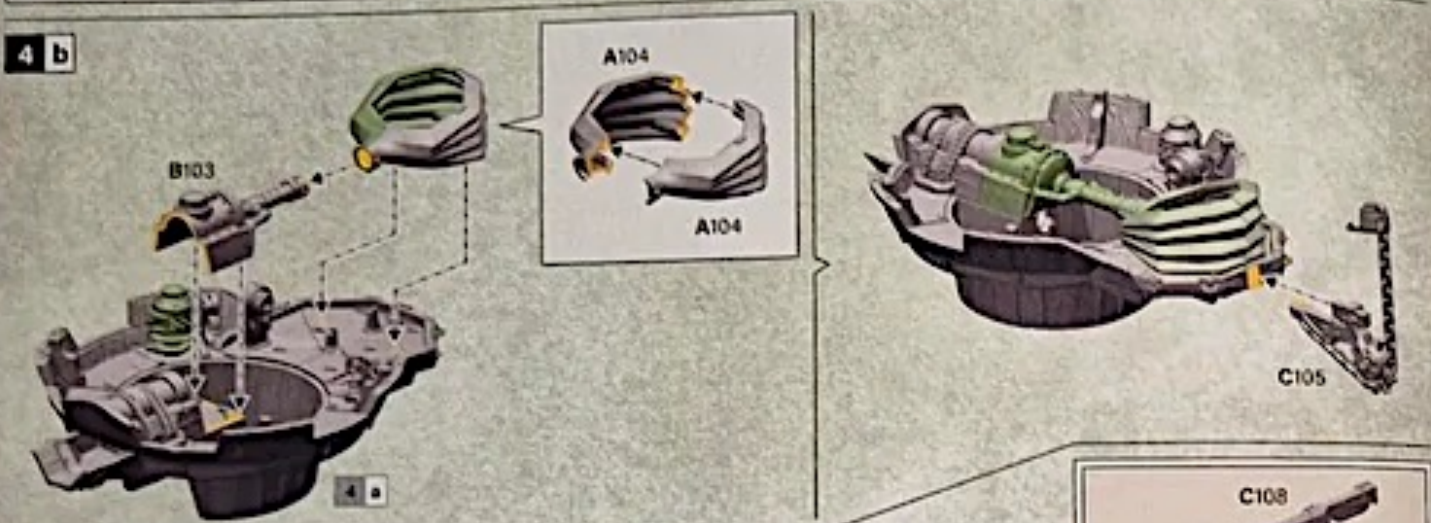
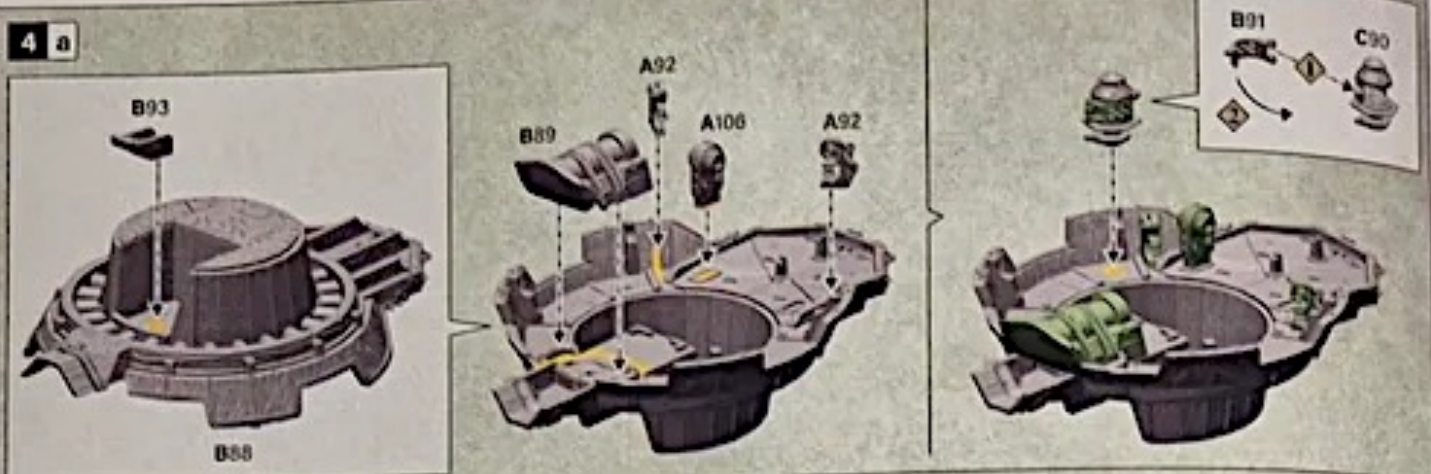

4 d

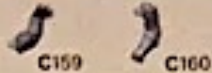
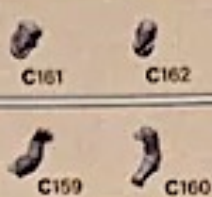
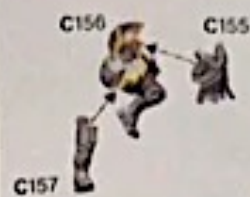

4 e

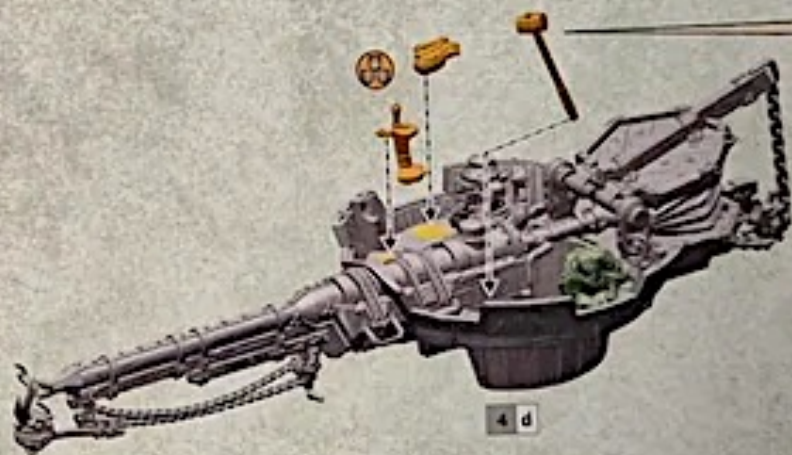

4 f

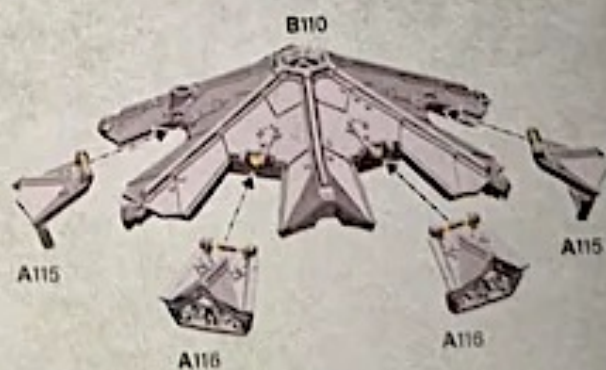

4 g**4 f**

C113

C114



B100

B109

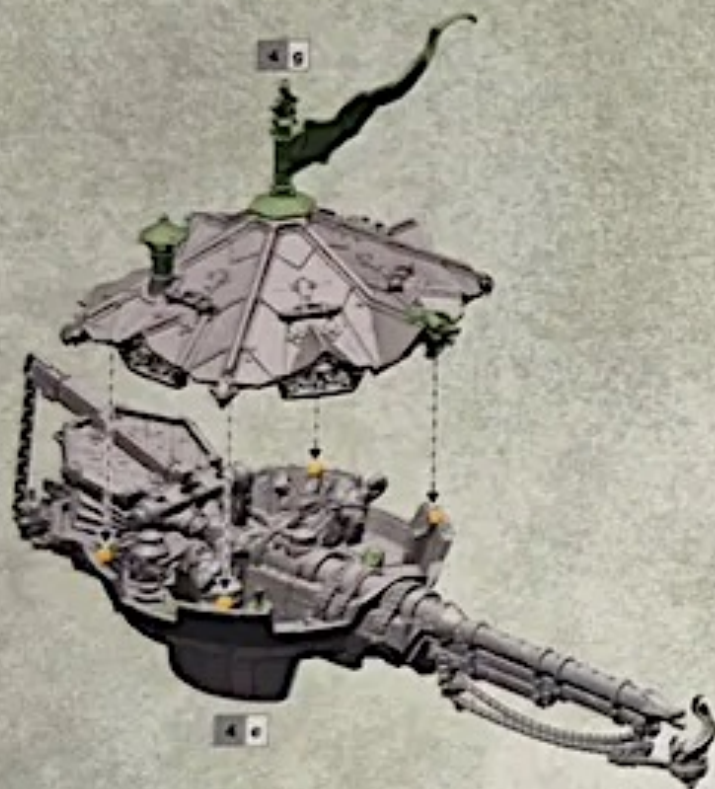
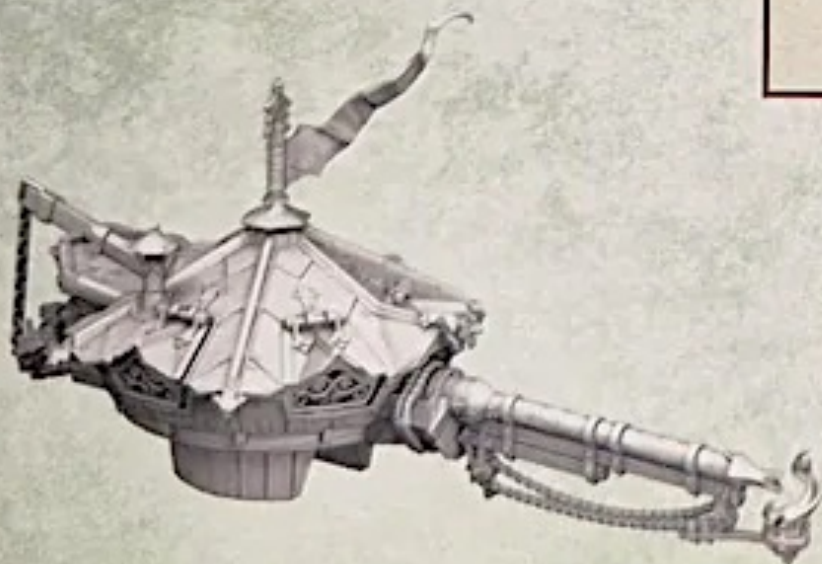
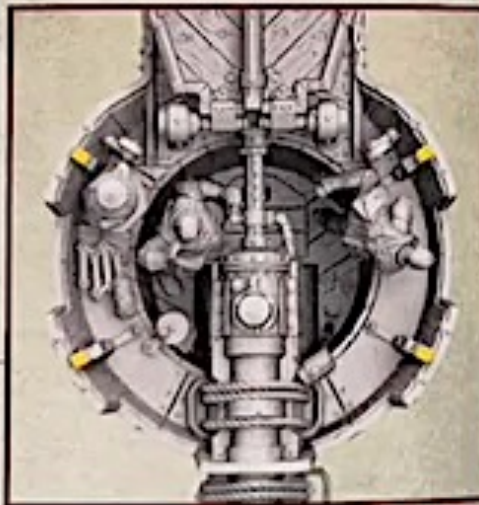
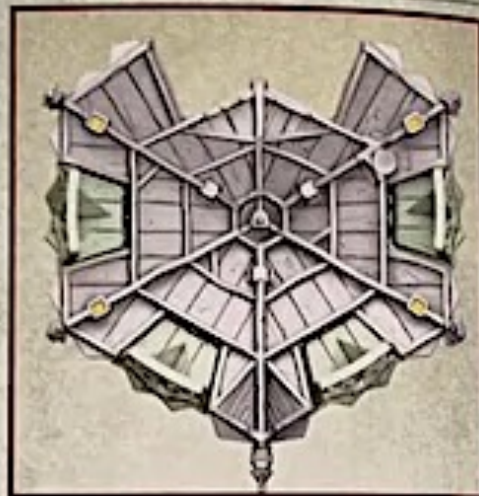
**4 h****4 g****4 e**

5 a

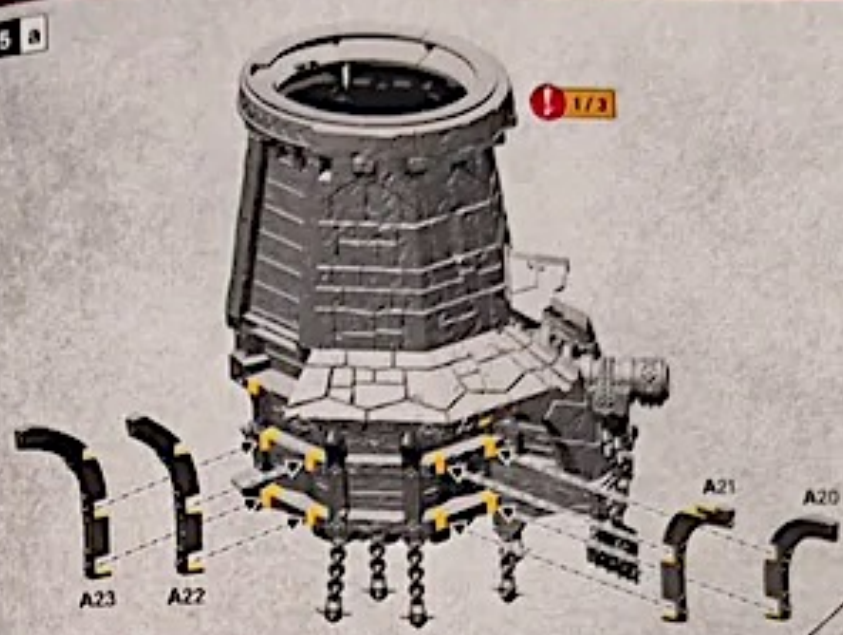

5 b

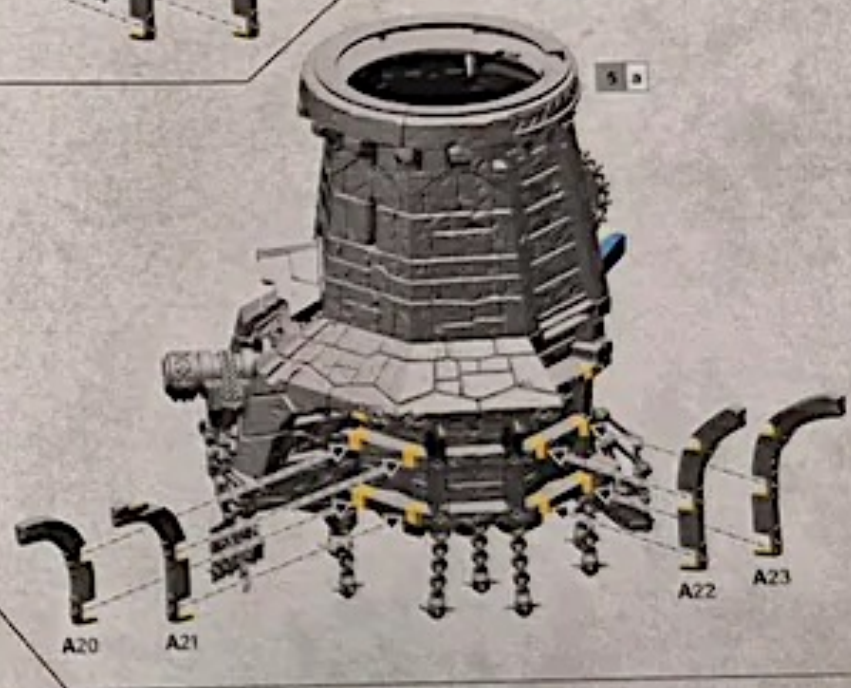
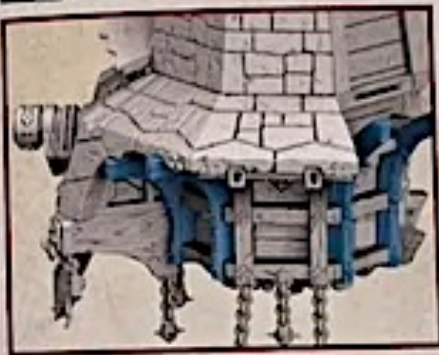

5 c

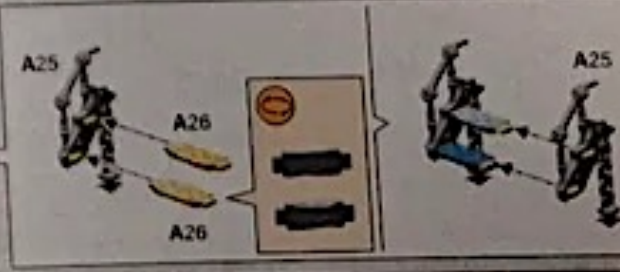
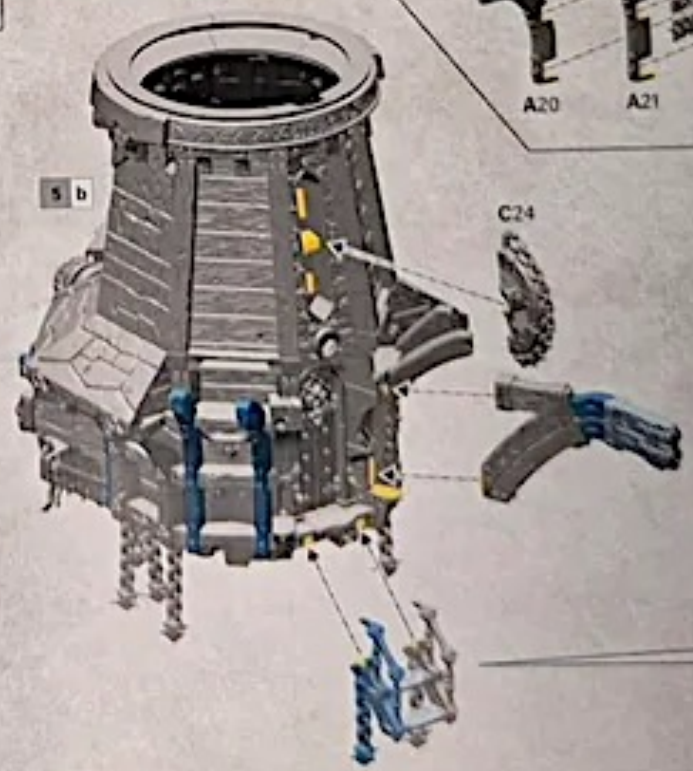

5 d

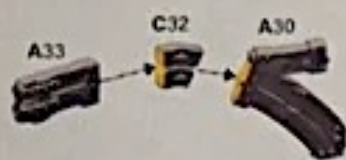

5 c

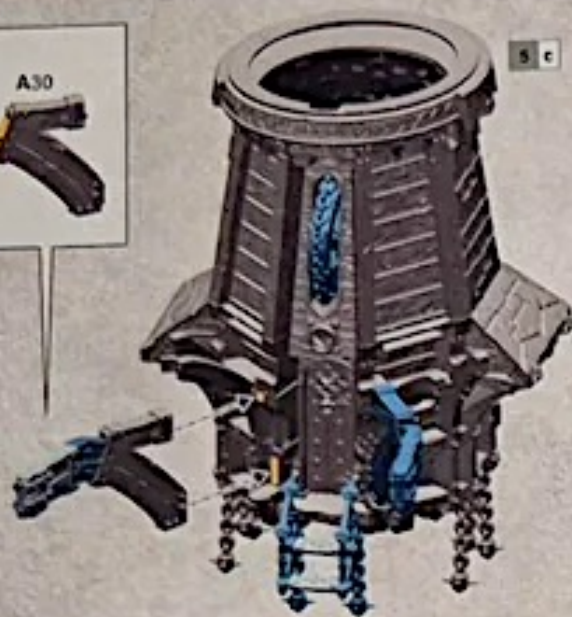

6 - 10

- Rotating the position of the four legs will lean the Cogfort at different angles • Faire pivoter les quatre pattes inclinera le Mécafort selon différents angles
- Rotar la posición de las cuatro patas cambiará el ángulo de inclinación del Fuerte Mecanizado
 - Je nach Positionierung der vier Beine neigt sich das Zahnradkastell in eine andere Richtung
 - Ruotare la posizione delle quattro zampe inclina il Forte Meccanico a diverse angolazioni
 - 4本の脚の位置を回転させることで、コグフォートをさまざまな角度に傾けることができる
 - 旋轉四支腿的位置會與軸空轉到不同的角度 • 네 다리를 회전하면 동니요새를 다양한 각도로 기울여 세울 수 있습니다



6

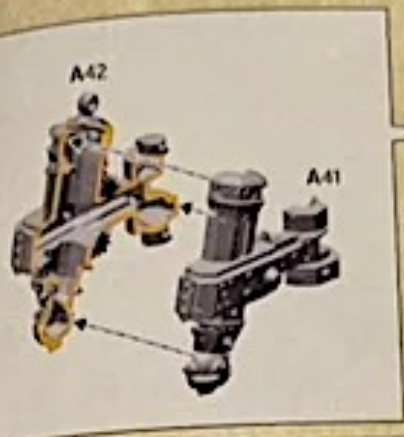

7

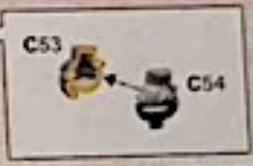
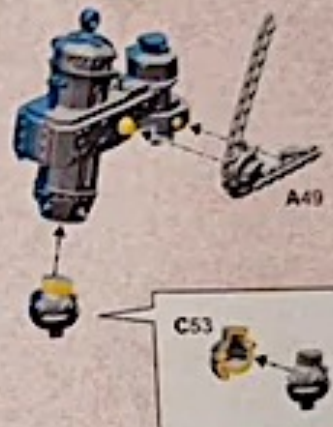

8



9

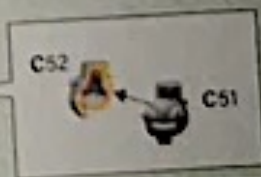
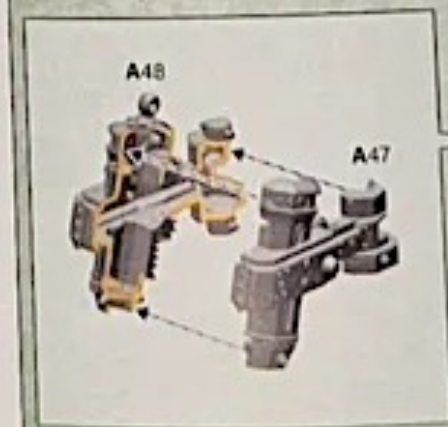

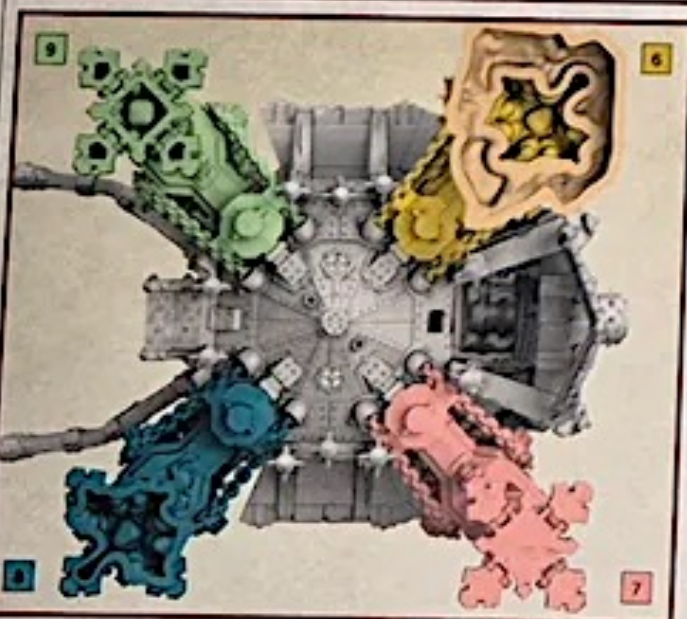
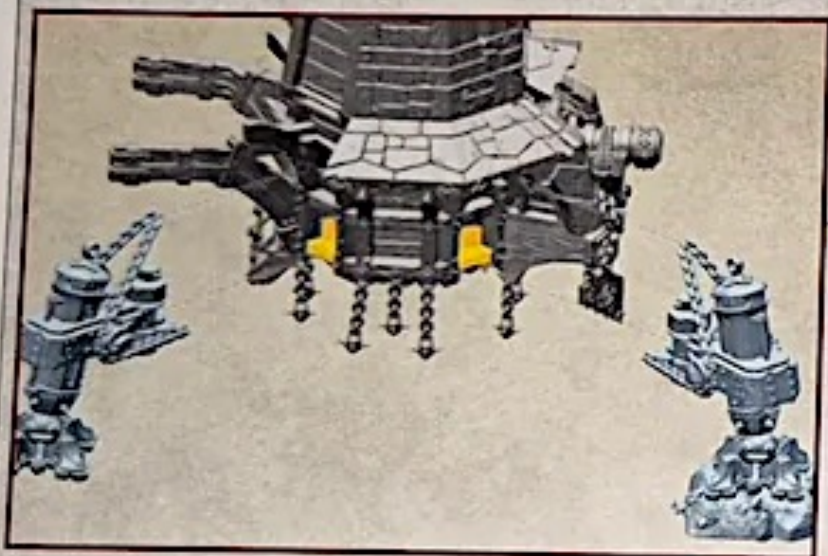

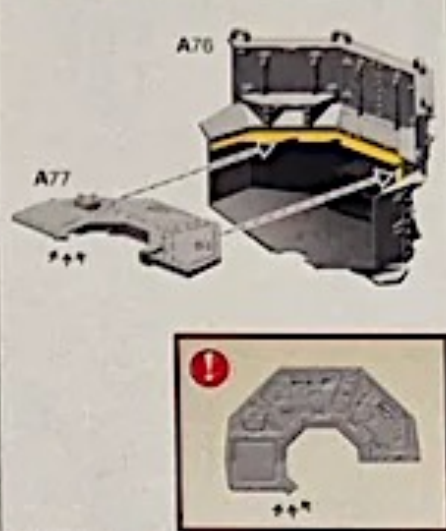
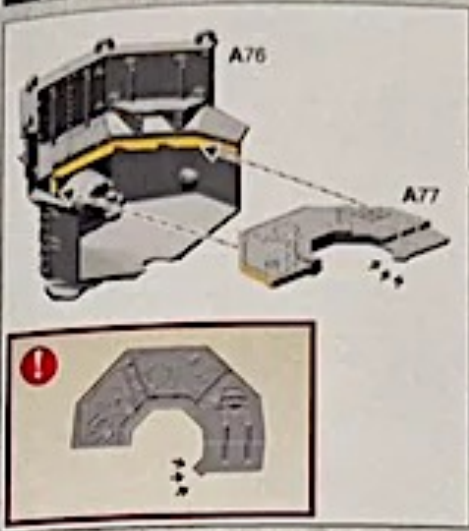
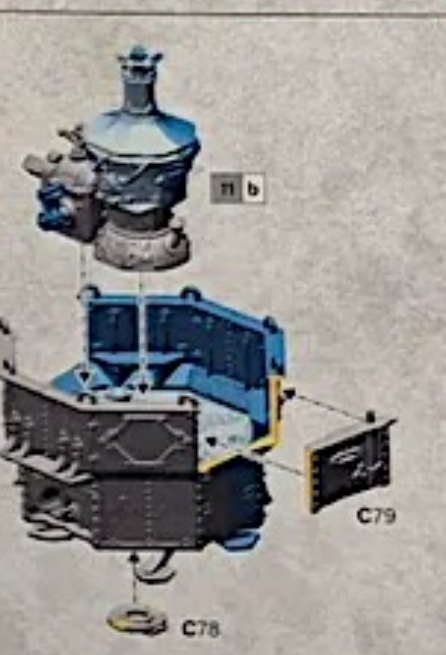
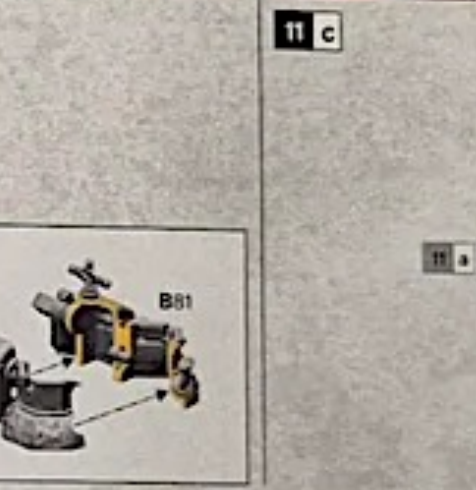
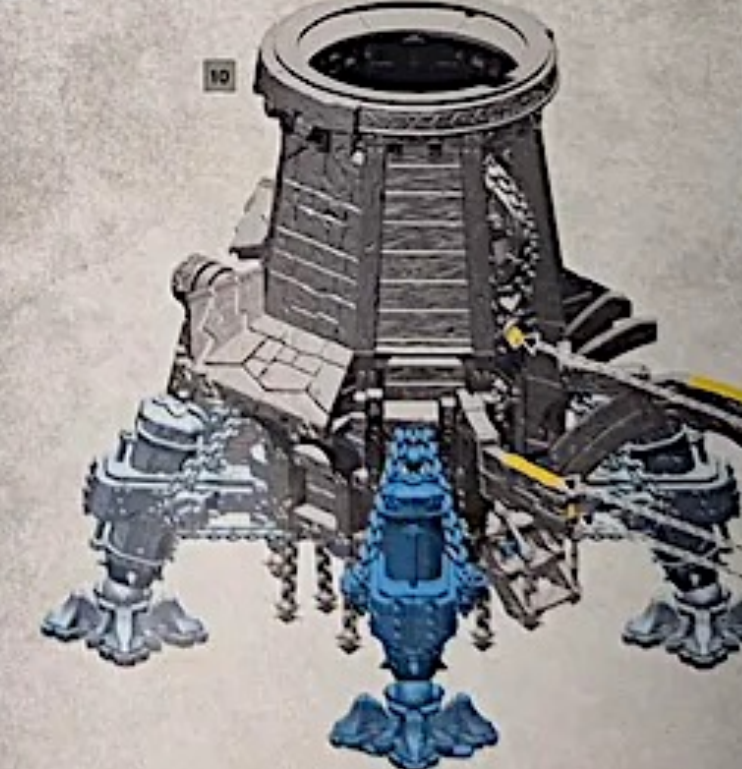
11 a**11 b****11 d**

11 e



11 d

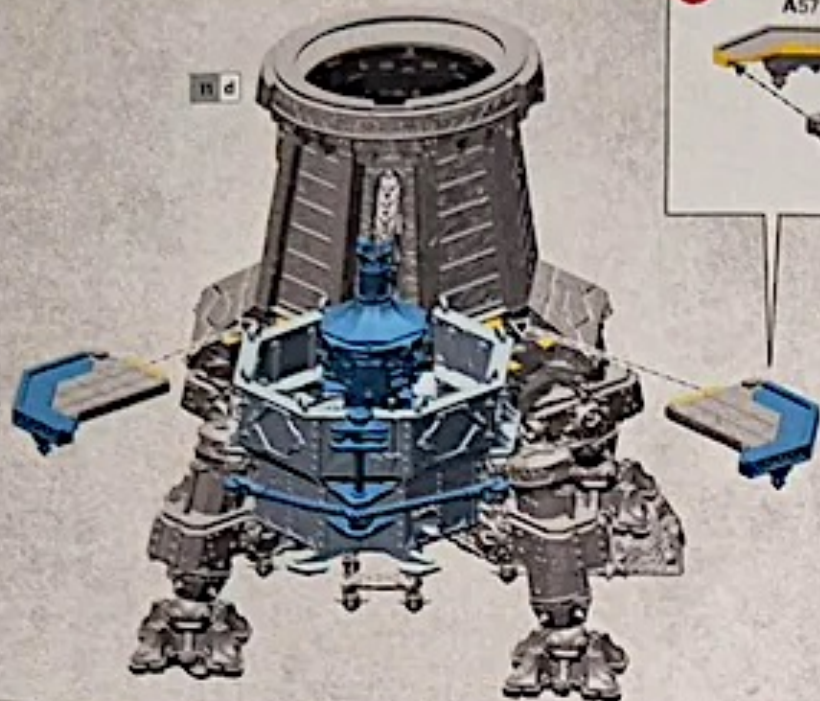

!

A57



A56

✓

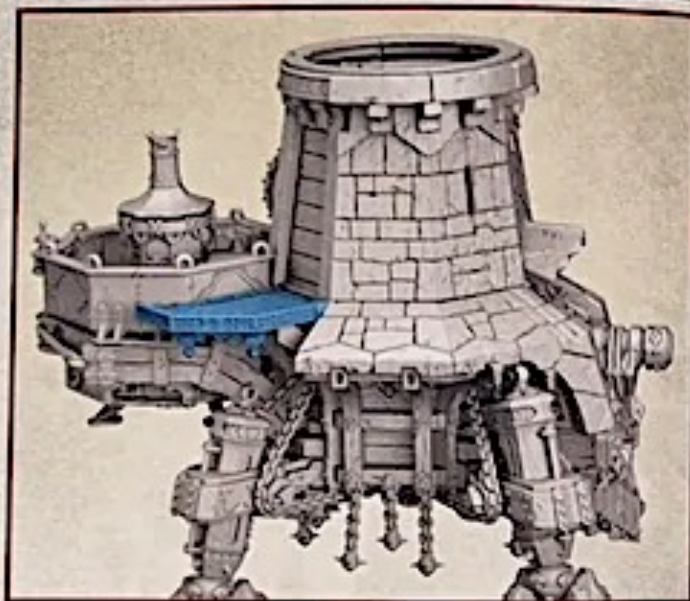
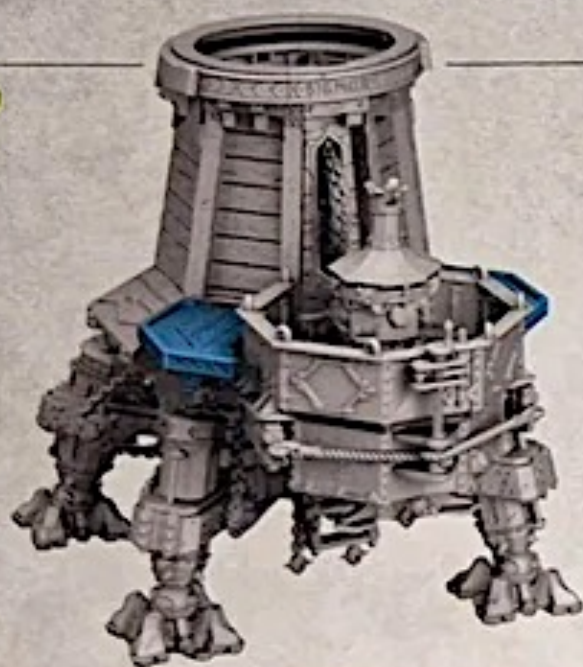

!

- Choose the variant you want to build
- Choisissez la variante à assembler
- Elige qué versión quieres montar
- Wähle die Variante, die du bauen möchtest
- Scegli la variante che vuoi assemblare
- 組み立てバリエーションの選択
- 選擇你喜歡的積裝方式
- 조합 옵션을 선택하세요

! 12



! 13



12 a



12 b

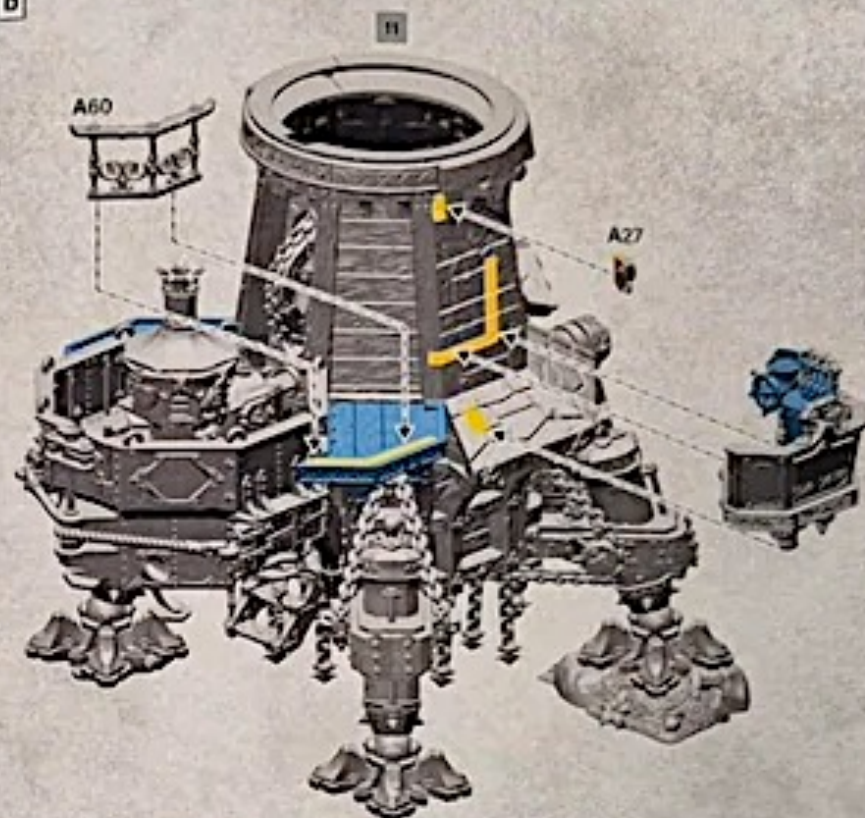

12 a



12 c

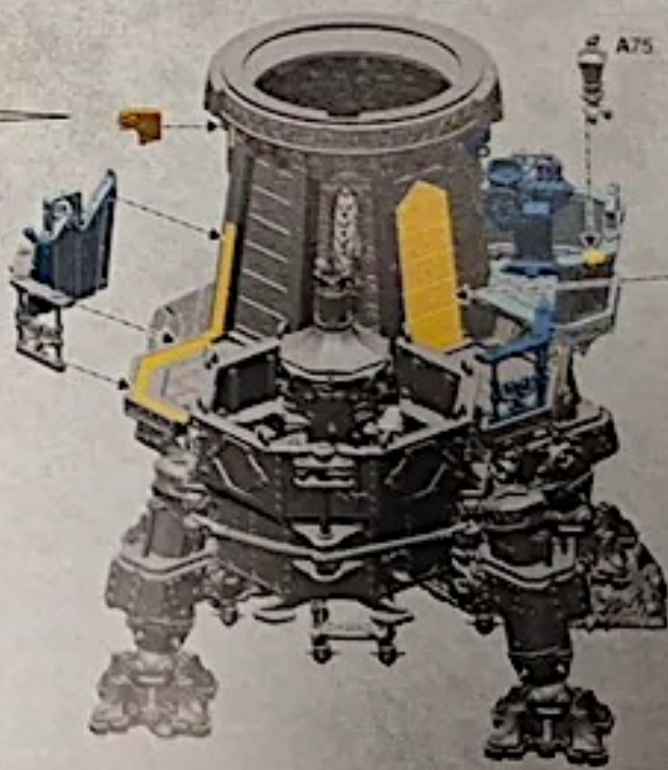
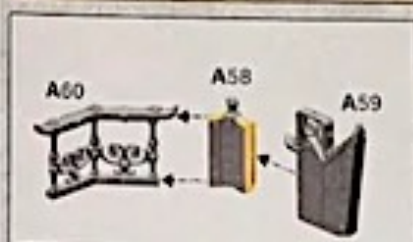
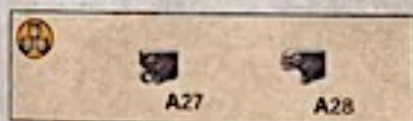

12 b

! 13 a

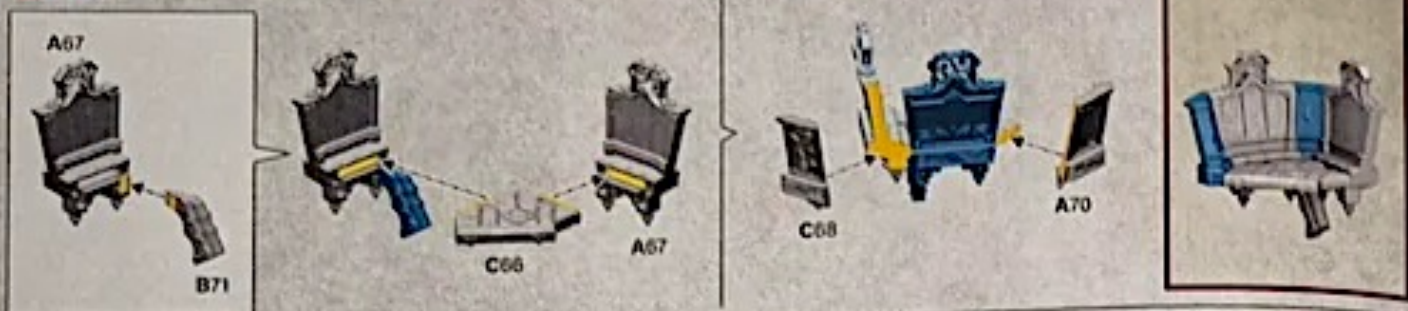

! 13 b

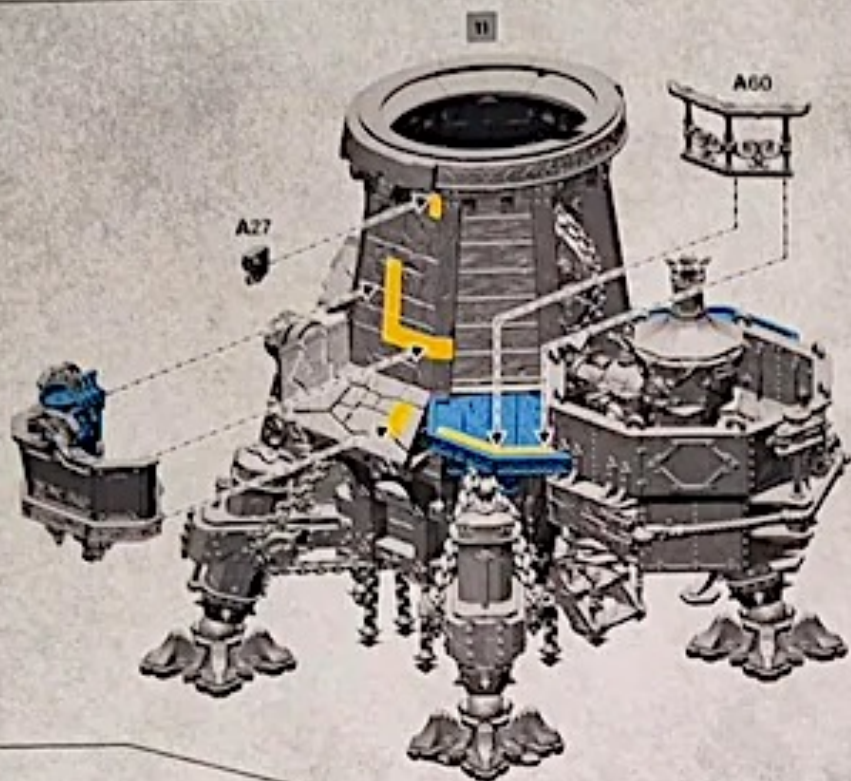
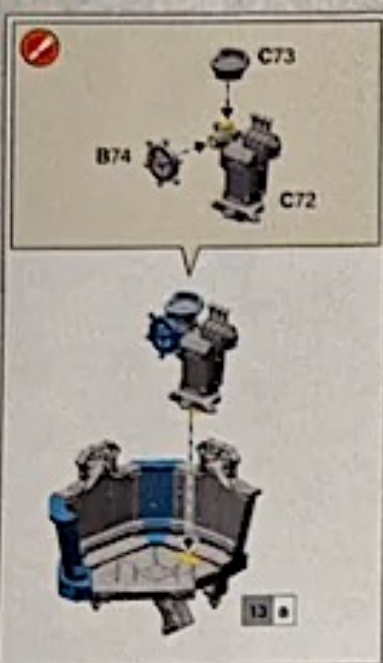

! 13 c

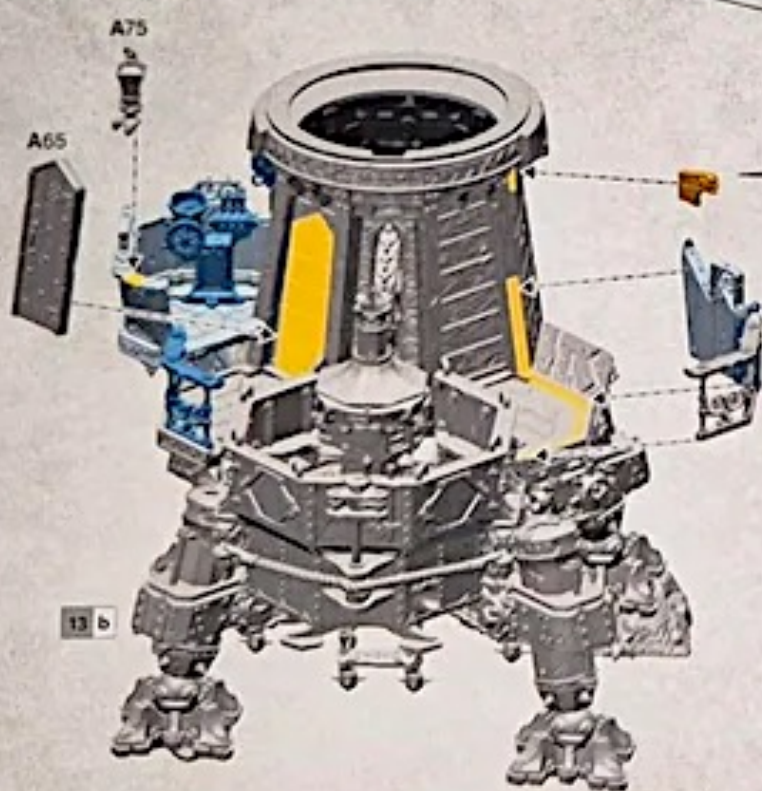

14 a



A62

A62

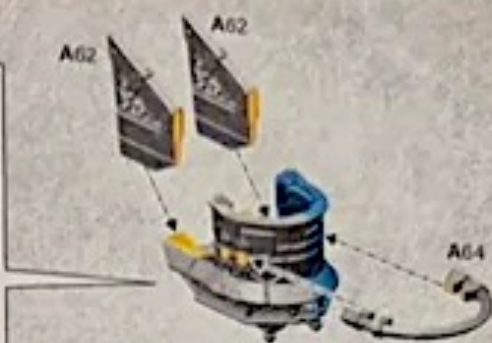

A64



14 b

- Choose the variant you want to build
- Choisissez la variante à assembler
- Elige qué versión quieres montar
- Wähle die Variante, die du bauen möchtest
- Scegli la variante che vuoi assemblare
- 組み立てバリエーションの選択
- 選擇你要做的組裝方式
- 소팅 옵션을 선택하세요



14 b

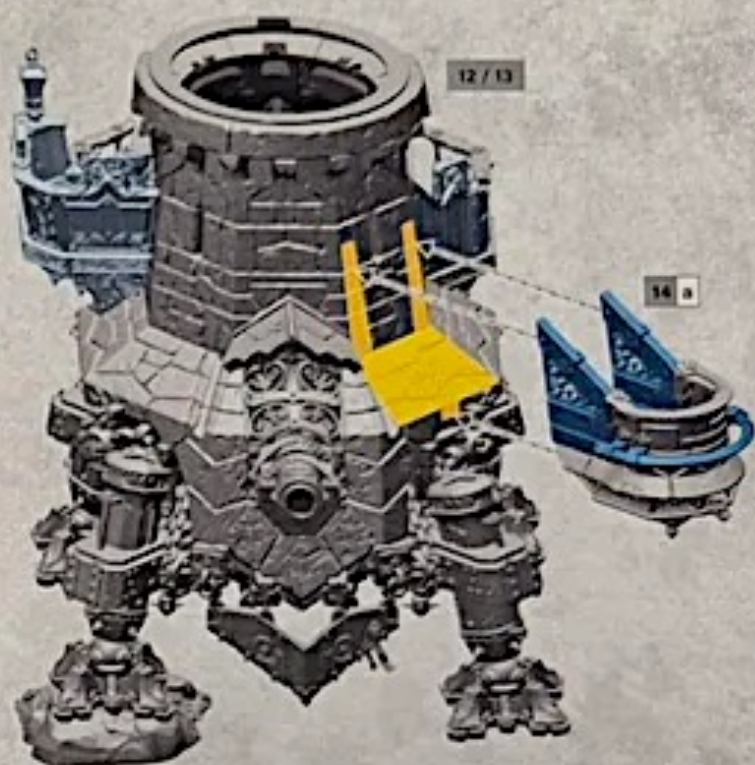

14 a

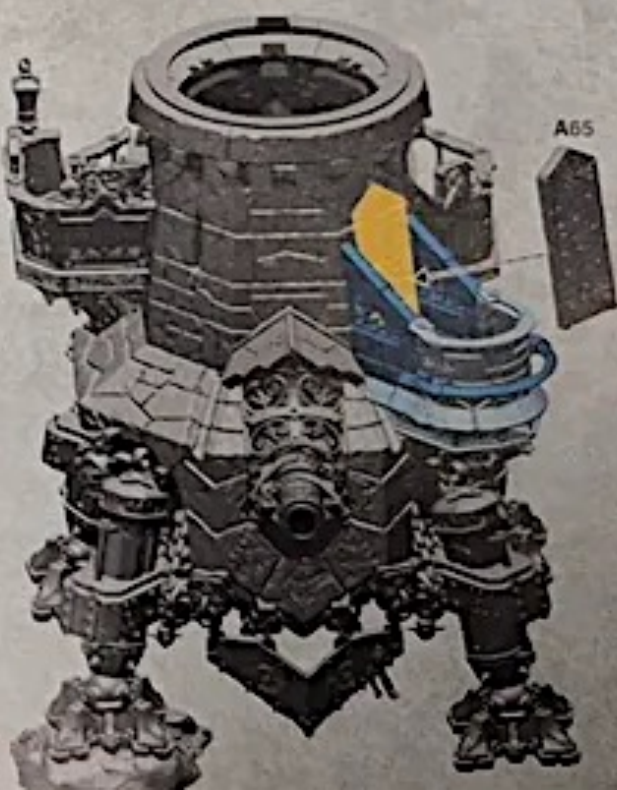

A65

14 c



14 b



B120

C121

C122

C123 C124 C125 C126

14 d

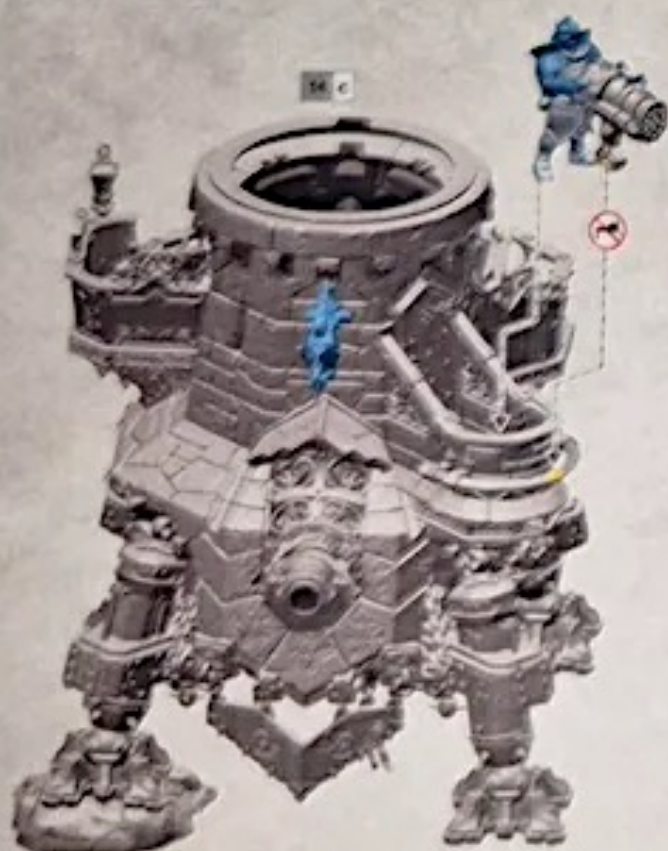

14 c



C131

C130

C135

C132

C133

C134

A129

A128

A127

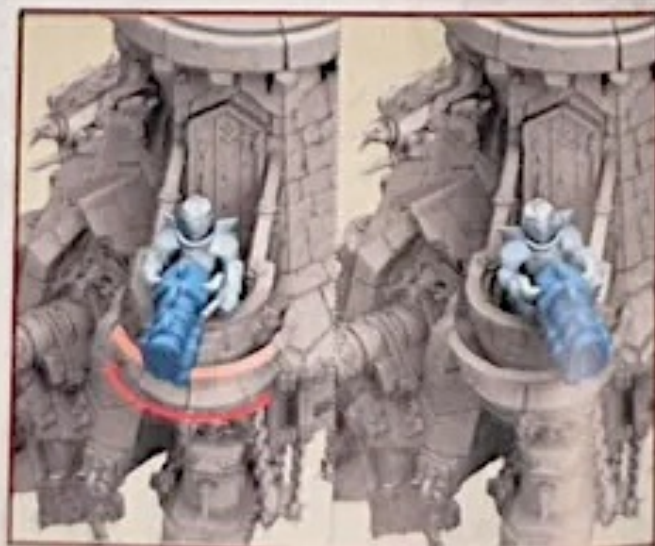

14 e

- Cliquez sur variant qui veut la build
- Choisissez la variante à assembler
- Cliquez sur variante qui veut monter
- Cliquez sur variante qui veut assembler
- 組み立てバリエーションの選択
- 選択済みのパーツを付ける
- 完成させる 2014年現在



14 d

C164



C165



C172



C173



C174

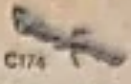

C175



C163

C168



C169



14 e

C166



C167



C172



C173



C174

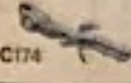

C175



C163

C170



C171



14 f

14 e



14 d



14 g

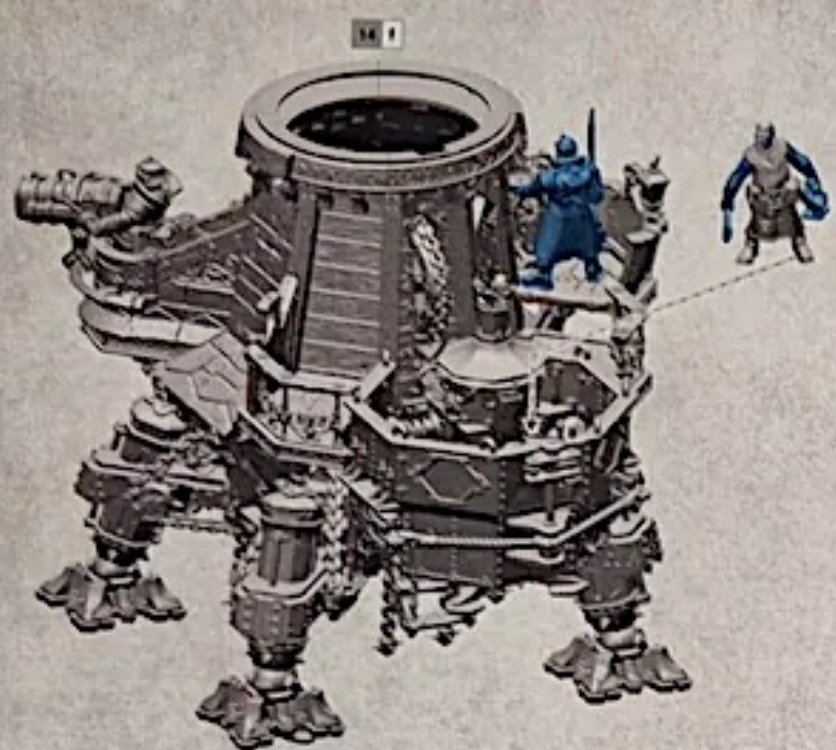

14 h

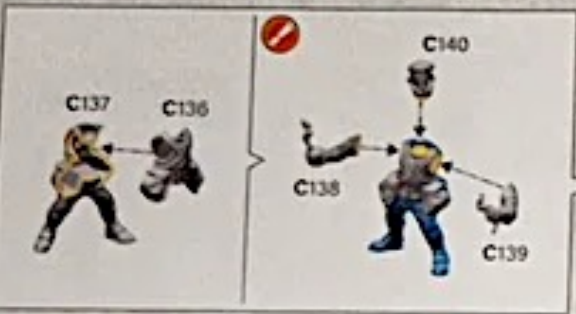

2/4

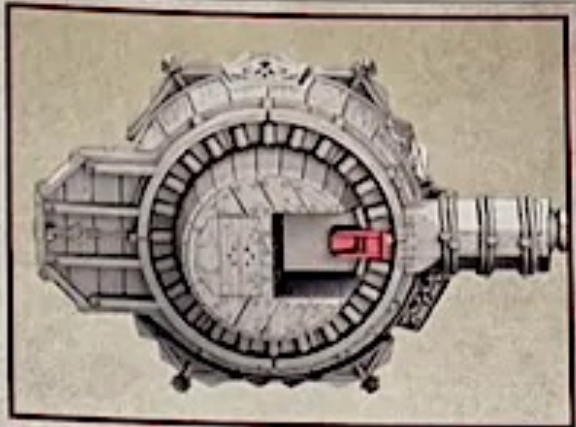
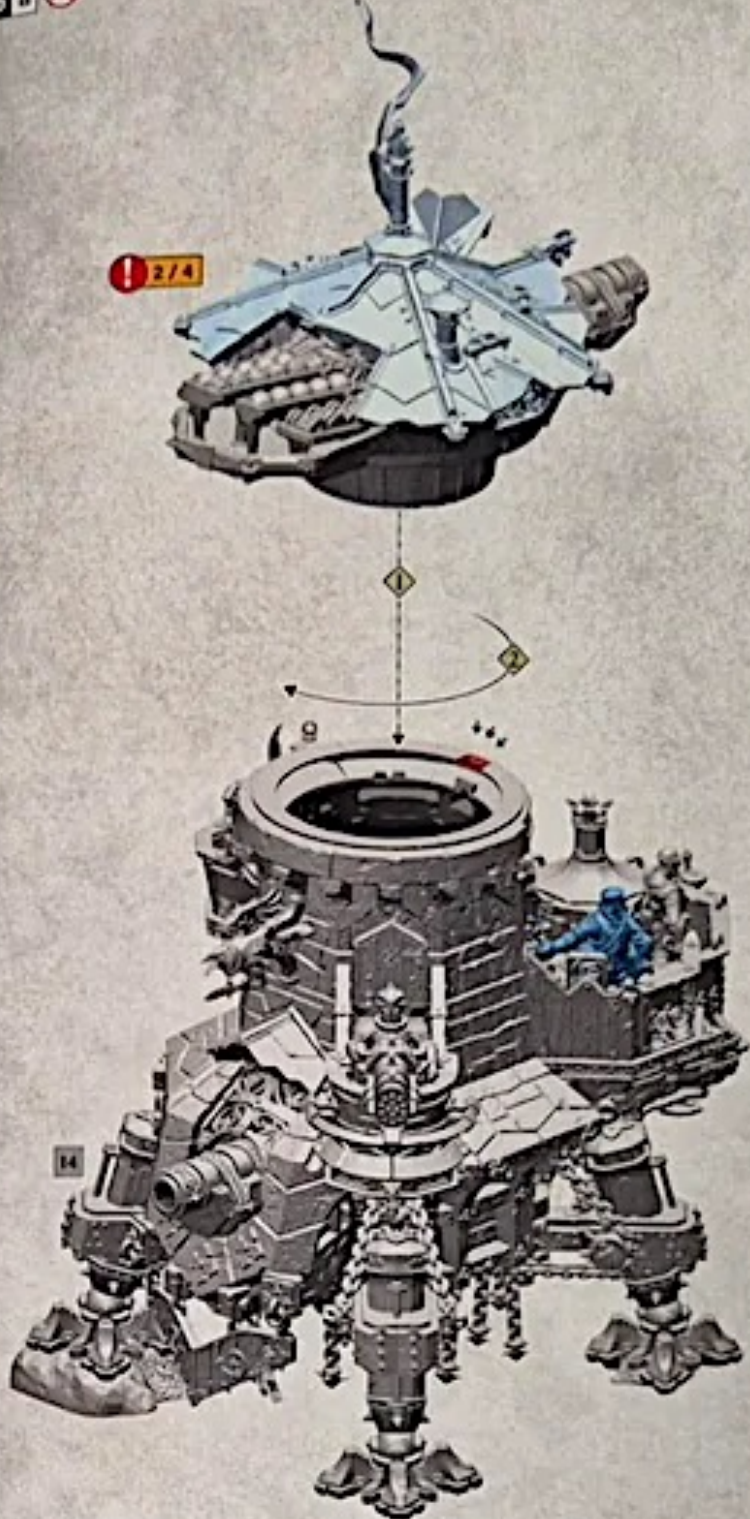

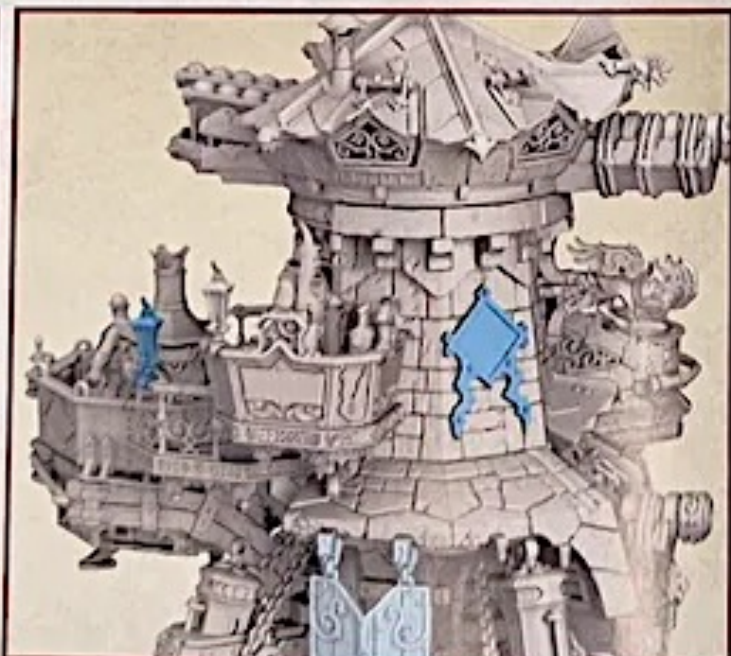
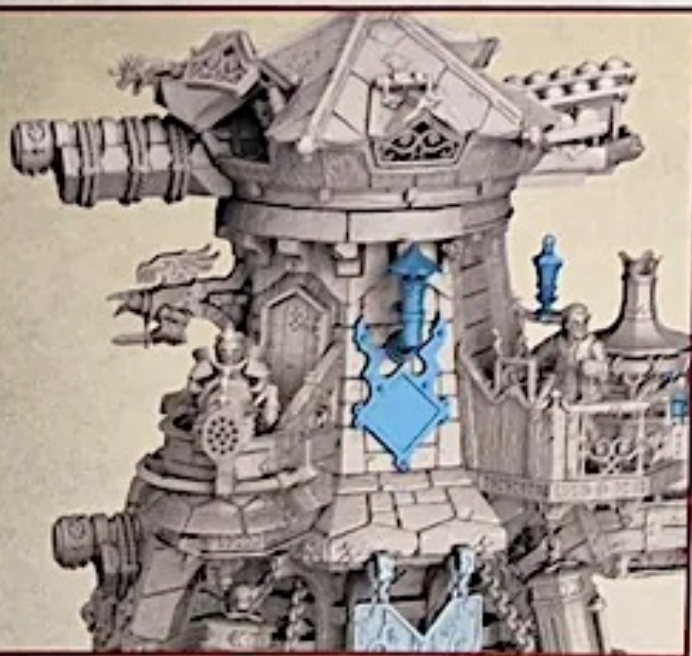

Apply decal first • Appliquez les décalcomanies d'abord
 Aplica primero la calcomanía • Zuerst Abziehbild auftragen
 Aplica primero le decalcomanía • 先にデカールを貼り付ける
 先貼し標紙紙 • 먼저 데칼을 붙여주세요



15 b



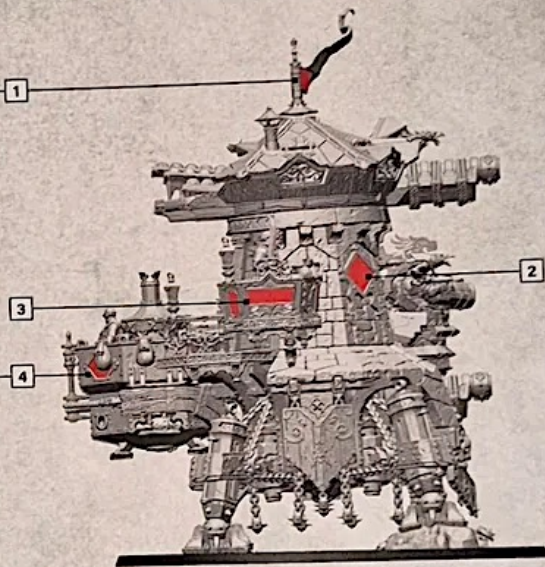
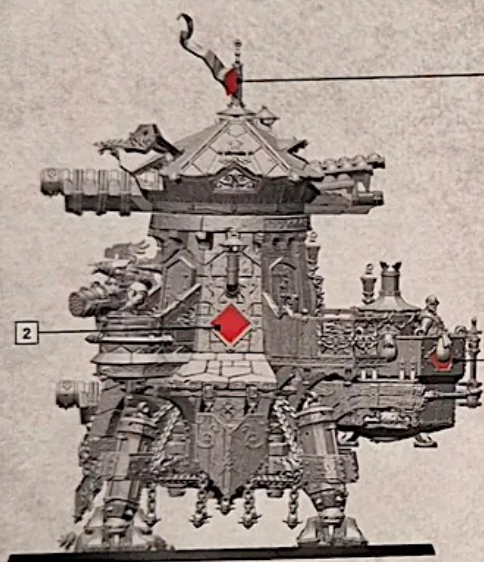
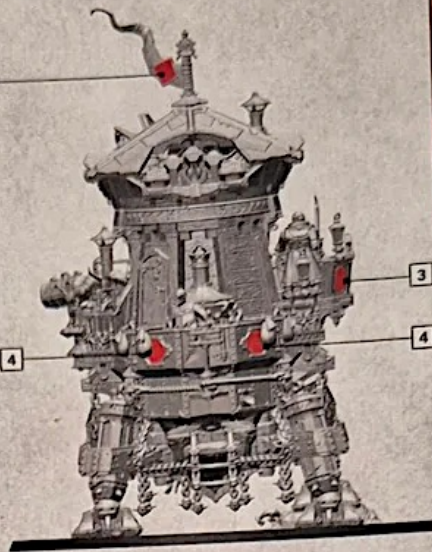
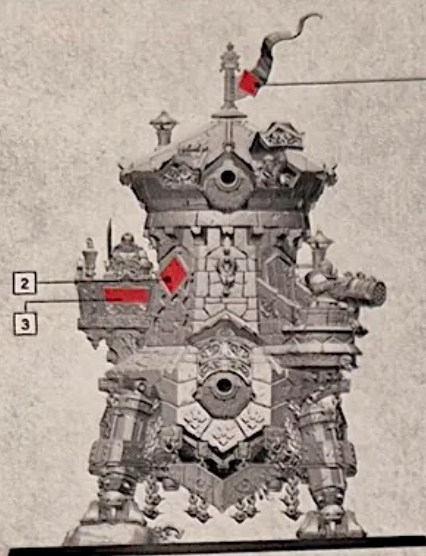

Cities of Sigmar Cogfort Transfer Sheet

COMPONENT CODE: 9851020002 © GAMES WORKSHOP 2026

City Hierarchy

Prisoner Hierarchy

Engineer Guilds

1

2

1

4

3

Green Drake
Death Wagon • Blade Golden • Last • Dark
Bastion Hush • Iron Shield • Best Steel
Silver Brass • Zee • War • Stone Valiant
Lion Goliath • Hound Gryphon Raven Harrier
Warden Warden Chaman • Chaman • Asha • Ghur
Shah • Suman • Mader • Pale • First Bled

