



Free Downloads of Build Instructions,
Assembly Booklets & How To Guides

BuildInstructions.com

WARHAMMER THE HORUS HERESY

LEGIO CUSTODES BATTLE GROUP



READ THIS FIRST | À LIRE EN PRIORITÉ | BITTE BEACHT E | LEE ESTO PRIMERO | LEGGI PRIMA QUESTO | 最初にお読みください。| 请优先阅读

ENG BEFORE ASSEMBLING YOUR MINIATURES, PLEASE READ THROUGH THE INSTRUCTIONS IN THIS BOOKLET CAREFULLY.

A pair of plastic cutters is required to remove the plastic components in this kit from their frame. We advise using a mouldline scraping tool to clean up the parts. To assemble your model you will need plastic glue. Games Workshop sells Citadel Fine Detail Cutters, Citadel Mouldline Removers and Citadel Plastic Glue, but does not recommend these products for use by children under the age of 16 without adult supervision.

FRE AVANT D'ASSEMBLER VOS FIGURINES, VEUILLEZ LIRE ATTENTIVEMENT LES INSTRUCTIONS DE CE LIVRET.

Une pince coupante est requise pour détacher chaque élément de sa grappe plastique. Nous vous recommandons l'utilisation d'un ébarboir pour gratter chaque élément. Pour l'assemblage, vous aurez besoin de colle plastique. Games Workshop commercialise les Pinces de Précision Citadel, l'Ébarboir Citadel et la Colle Plastique Citadel, mais n'en recommande pas l'utilisation aux enfants de moins de 16 ans sans la supervision d'un adulte.

SPA POR FAVOR, LEE CUIDADOSAMENTE ESTE LIBRETO DE INSTRUCCIONES ANTES DE EMPEZAR A MONTAR LAS MINIATURAS.

Te harán falta unas tenazas para plástico a fin de separar las piezas de la matriz. También aconsejamos una herramienta para quitar rebabas a fin de limpiar cada pieza. Para montar la miniatura necesitarás pegamento para plástico. Games Workshop vende Tenazas de detalle superfino, Quitarrebabas Citadel y Pegamento para plástico Citadel, pero no recomienda estos productos a menores de 16 años sin supervisión de un adulto.

GER VOR DEM ZUSAMMENBAU DER MINIATUREN BITTE DIE ANWEISUNGEN IN DIESER ANLEITUNG AUFMERKSAM DURCHLESEN.

Du benötigst einen Kunststoffseitenschneider, um die Kunststoffbauteile aus dem Gussrahmen herauszutrennen. Außerdem empfehlen wir, die Bauteile mit einem Gussgratentferner zu säubern. Um dein Modell zusammenzubauen, benötigst du Kunststoffkleber. Games Workshop bietet Präzisions-Seitenschneider und Gussgratentferner von Citadel sowie Citadel-Kunststoffkleber an, empfiehlt aber, dass Kinder unter 16 Jahren diese nur unter Aufsicht eines Erwachsenen benutzen.

ITA PRIMA DI ASSEMBLARE LE TUE MINIATURE LEGGI ATTENTAMENTE TUTTE LE ISTRUZIONI DI QUESTO LIBRETTO.

Sono necessarie un paio di tronchesine per plastica per staccare i componenti dai loro sprue. Consigliamo di usare un attrezzo apposito per pulire i componenti. Per assemblare il modello avrai bisogno di colla per plastica. Games Workshop vende Tronchesine di ultraprecisione Citadel, Attrezzo per ripulire Citadel e Colla per plastica Citadel, ma non consiglia questi prodotti ad un pubblico minore di 16 anni senza la supervisione di un adulto.

ENG 始める前に必ず説明書をお読みください。

本キット内のフレームからプラスチックパーツを切り離すためには、ニッパーが必要です。パーツのモールドを平らにするには、専用ツールを使用をお勧めいたします。本キットの組み立てには、プラ用接着剤が必要です。ゲームズワー
ップはスーパー・ファインディテール・カッター、シタデル・プラスチックグルー、シタデル・モールドラインリムーバーを販売しておりますが、16歳以下の子供が大人の監督なしにこれらの道具を使用されることをお勧めしません。

始める前に必ず説明書をお読みください。 请仔细阅读本手册中的说明。

SHIELD CAPTAIN

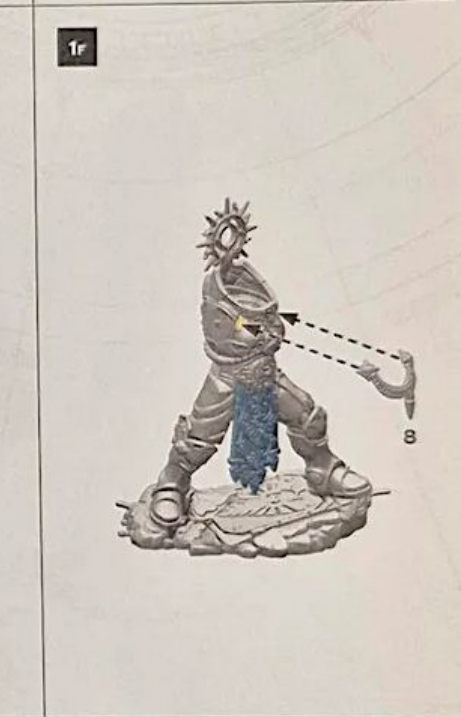
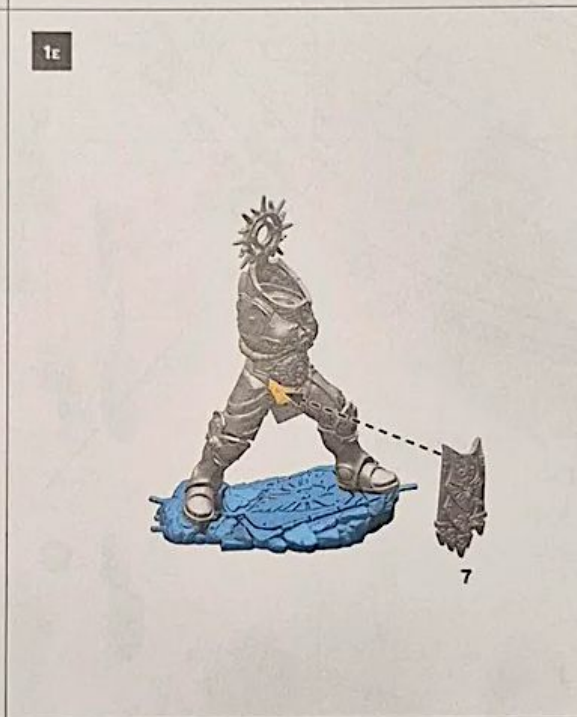
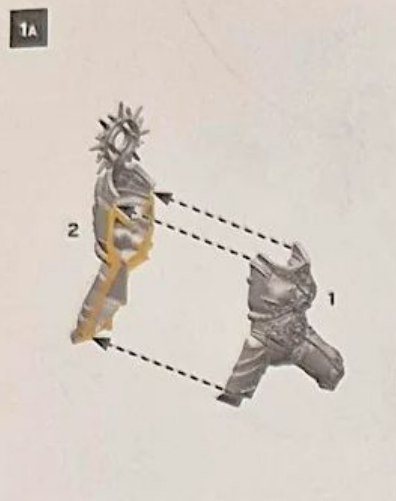

1j



18. Eternity Blade

1k



1l



19. Praesidium Shield

2a



2a



3



3



CUSTODIAN AND SENTINEL GUARD BODIES

BODY 1

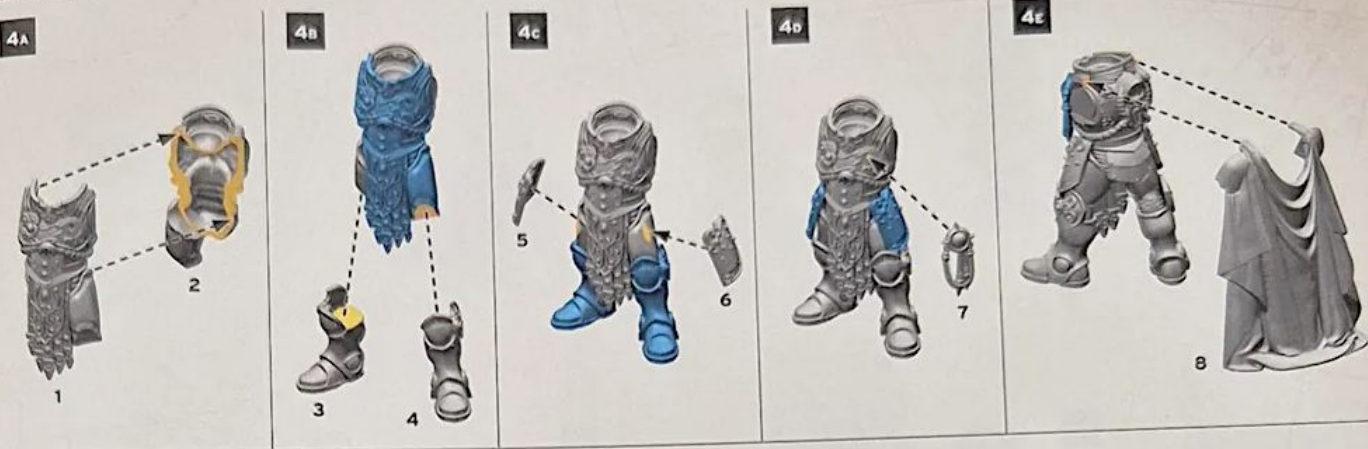

BODY 2



BODY 3

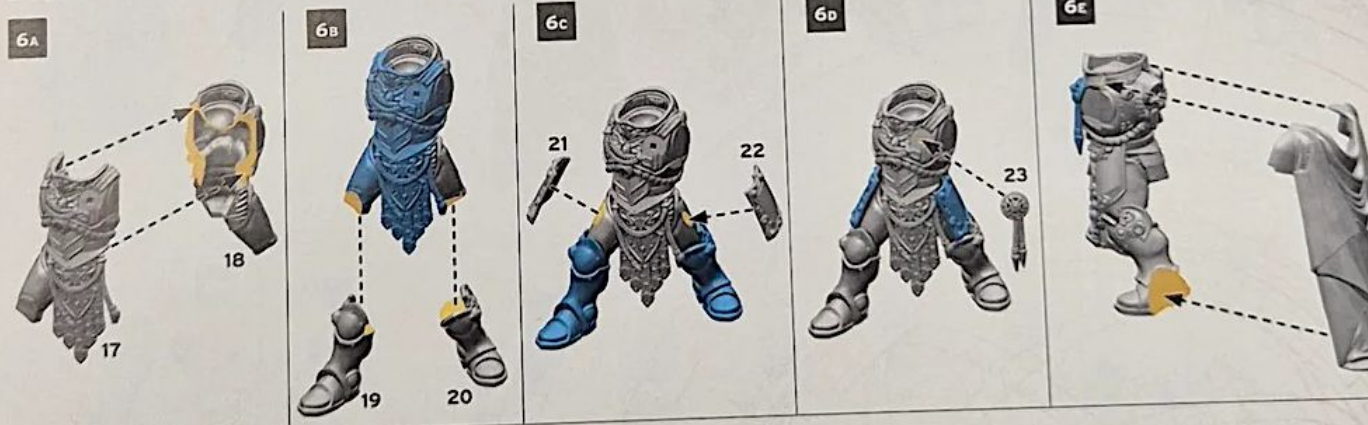

BODY 4



Body 5



Body 6

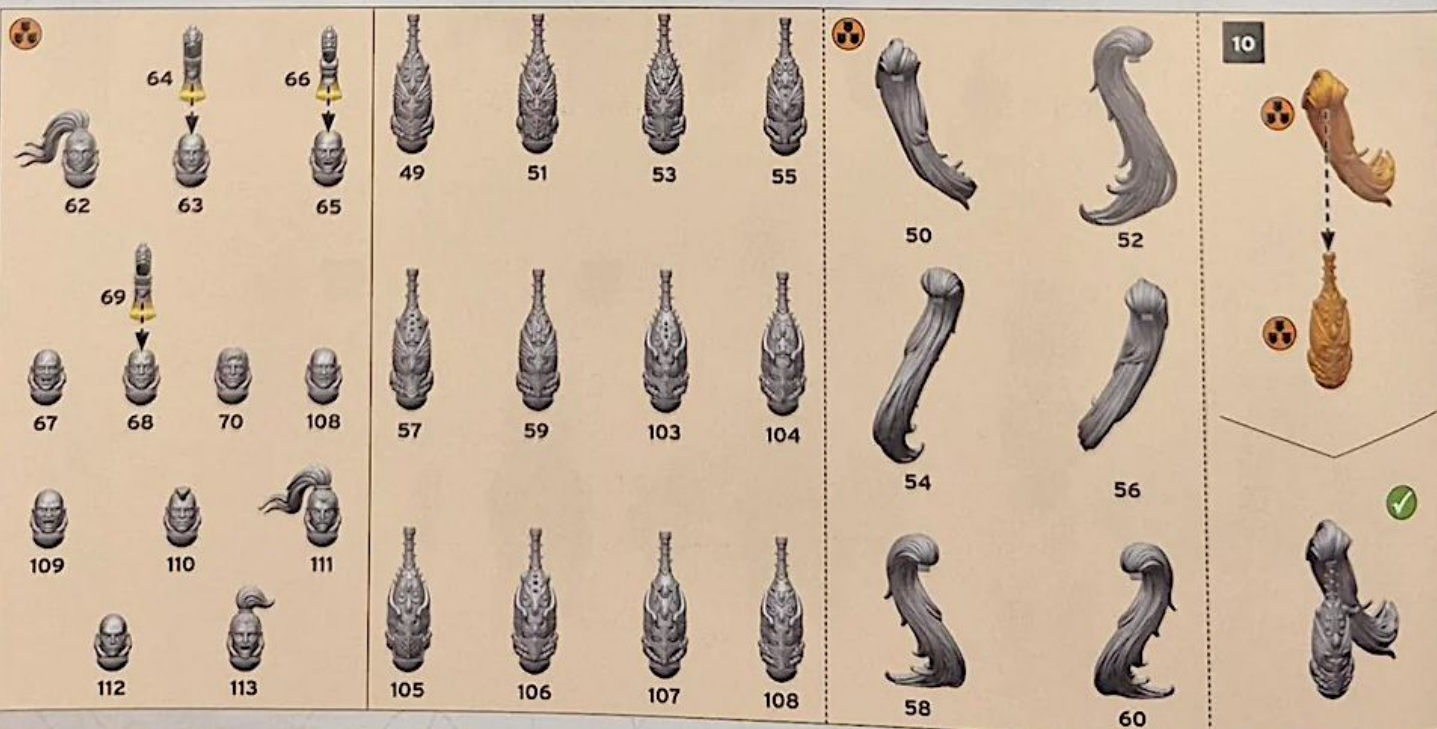
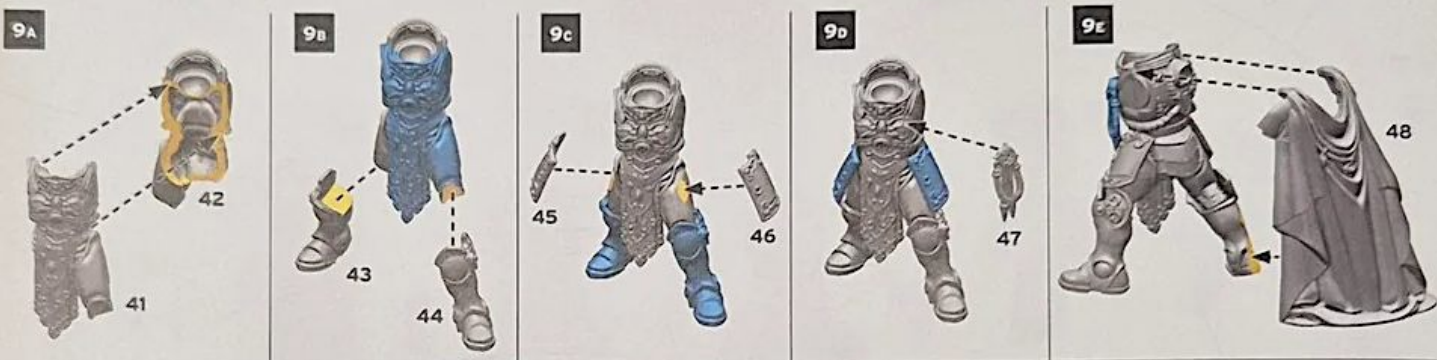

CUSTODIAN GUARD SODALITY

11a



11b

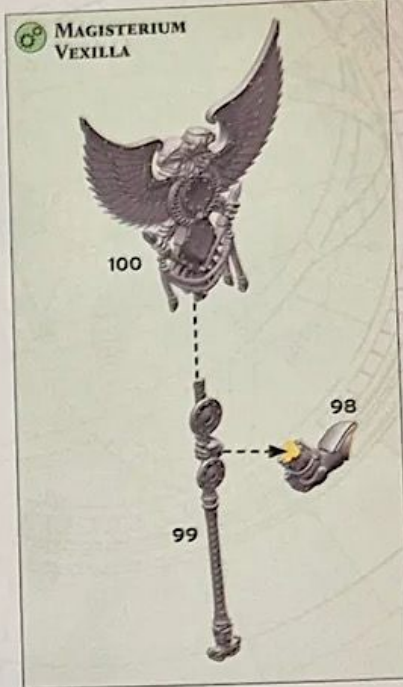

11c

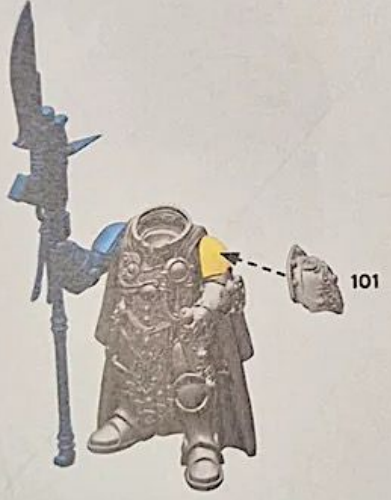

11d



11e



12a



12b



12c

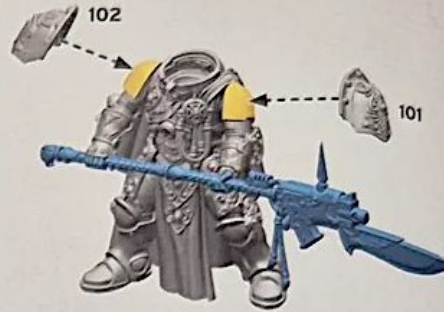

12d



13a



13b



13c



13d



14a

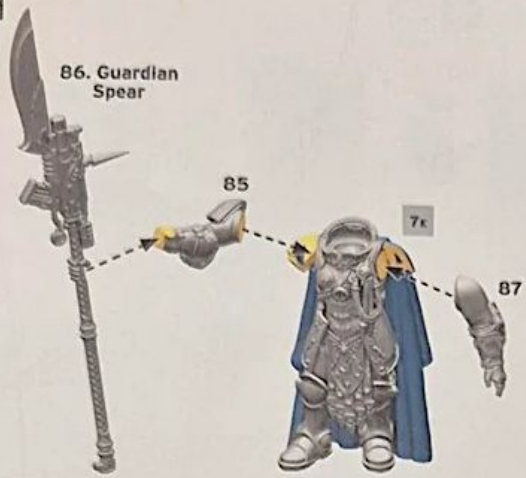

14b

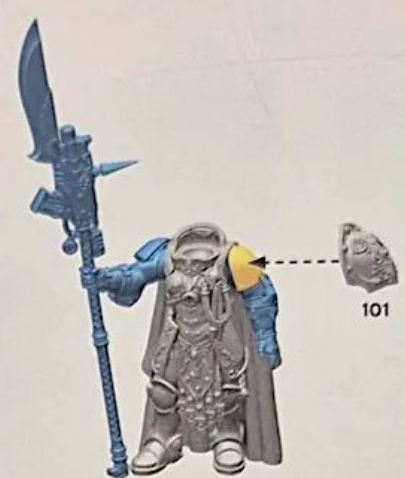

14c



14d



15a

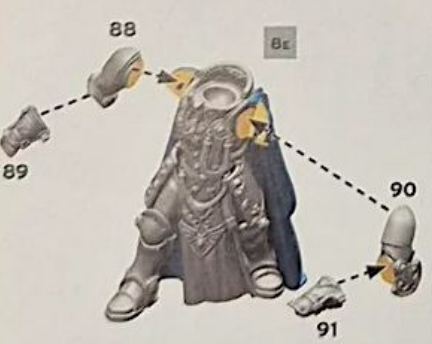

15b



15c



15d



16a



16b



16c



16d



SENTINEL GUARD SODALITY



95



96



97



98



99



100

17A - 17F



18A - 18E



17A



17B



17C



17D



17E



17F





19a



19a



19c



19b



20a



20b



20c



20b



21A



21B



21C



21D



22A



22B



22C

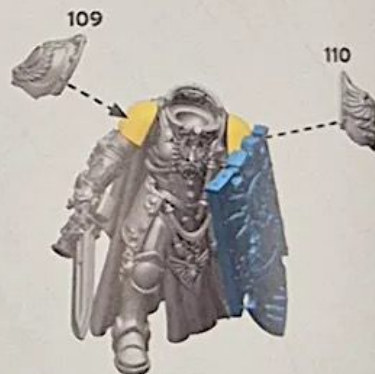

22D



23A



23B



23C

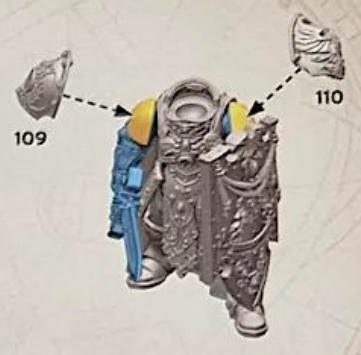

23D



CALADIUS ANNIHILATOR GRAY-TANK

24A

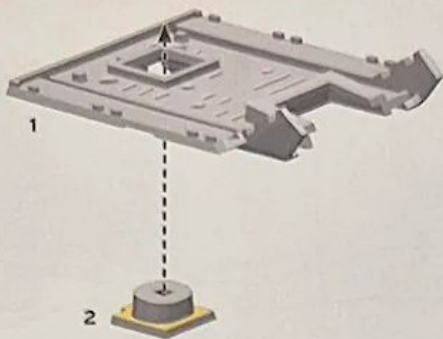

24B

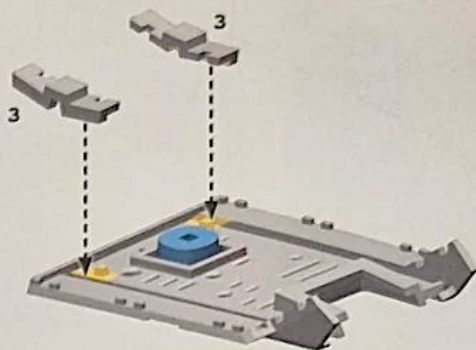

24C

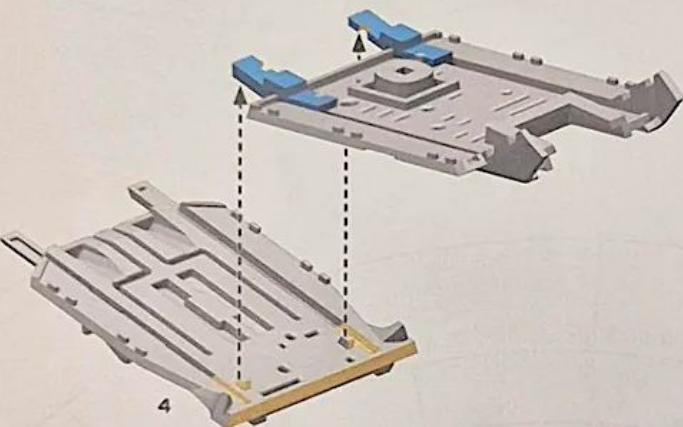

24D

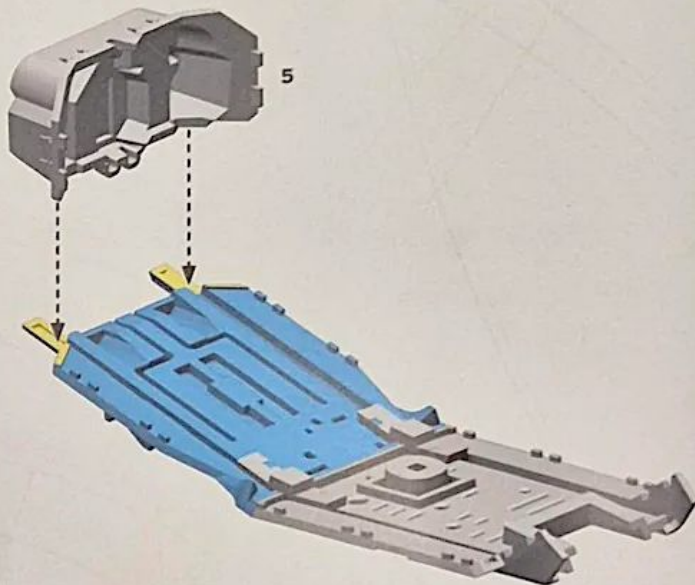

24E

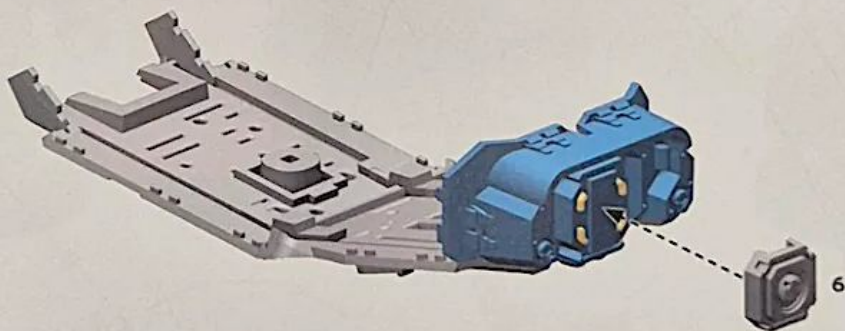

24F

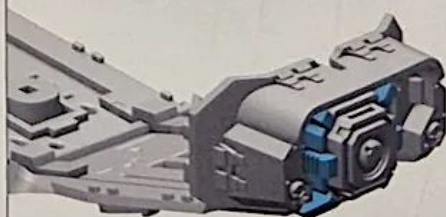
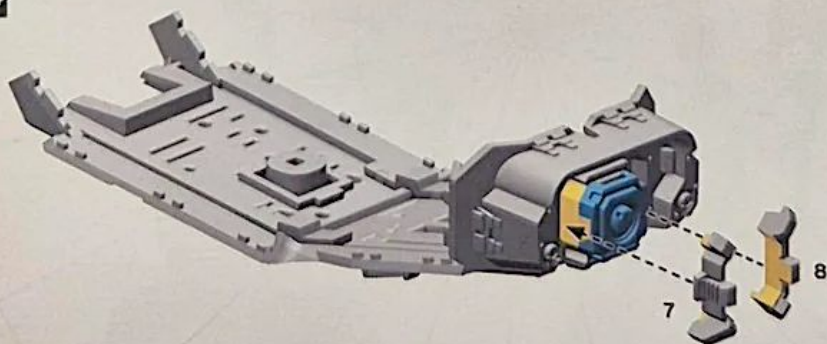

25A

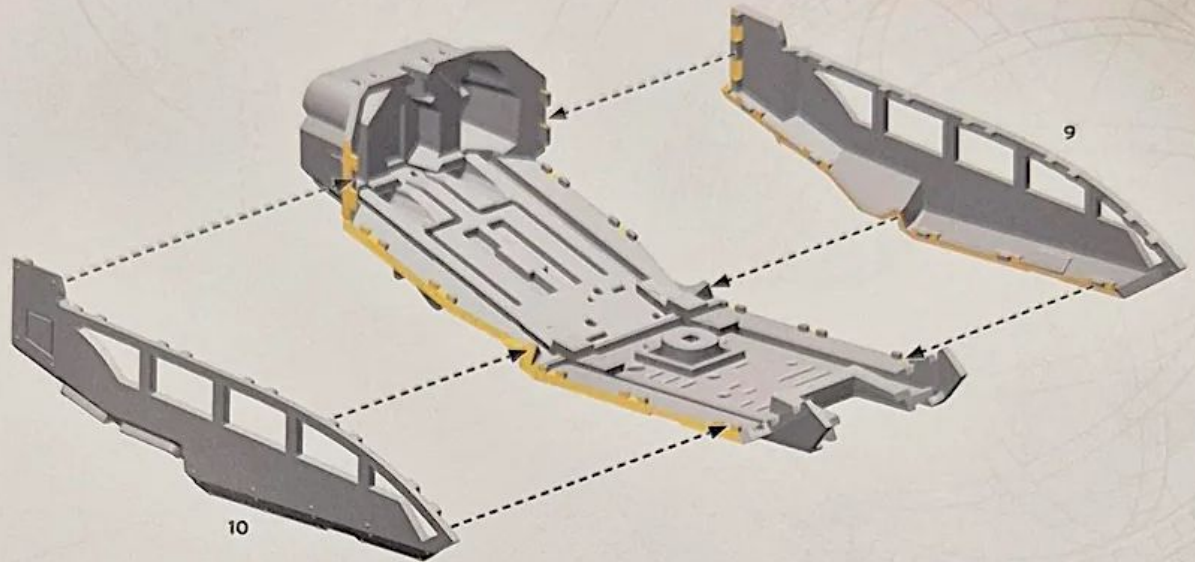

25B

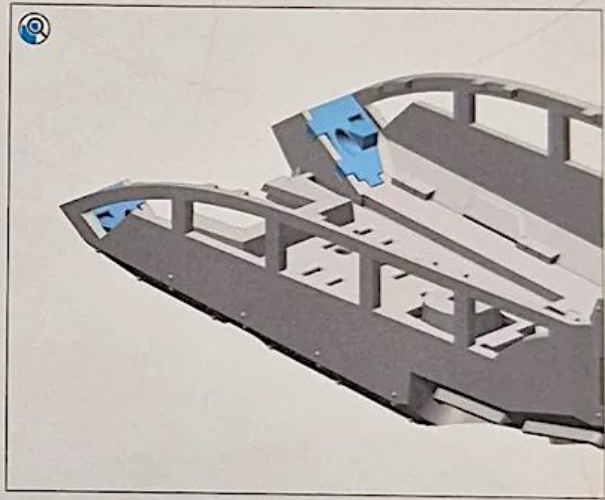
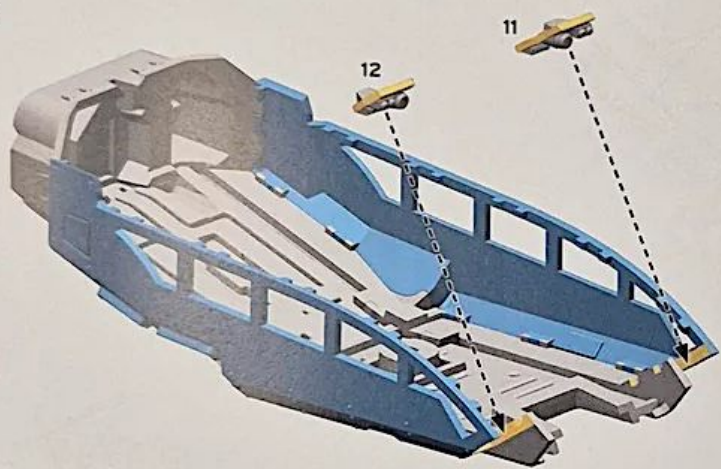

25C

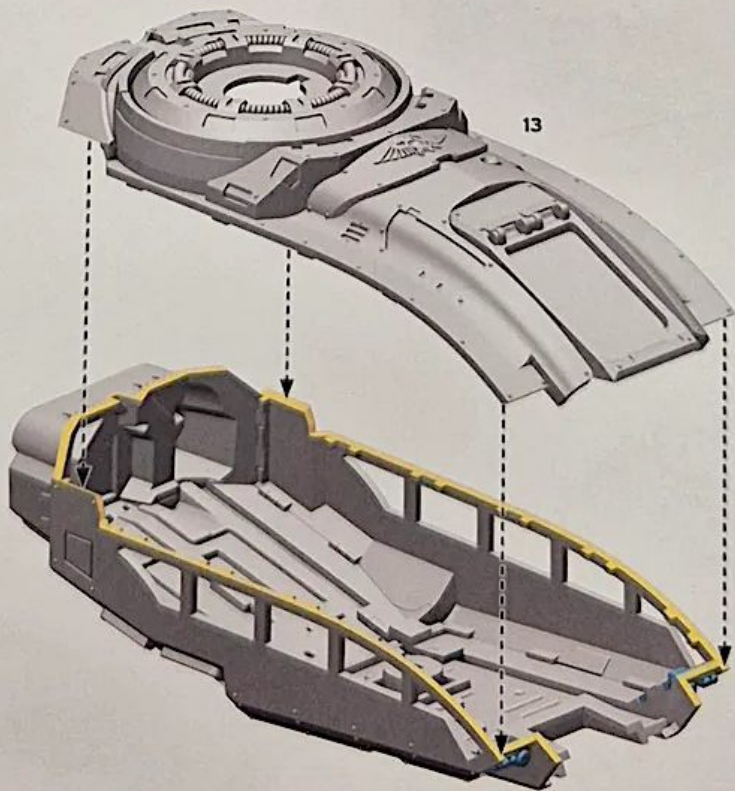

26A

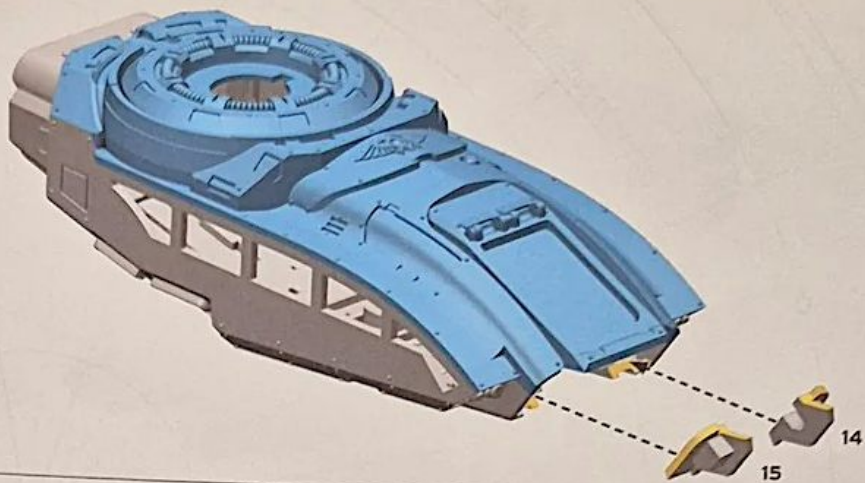

26B

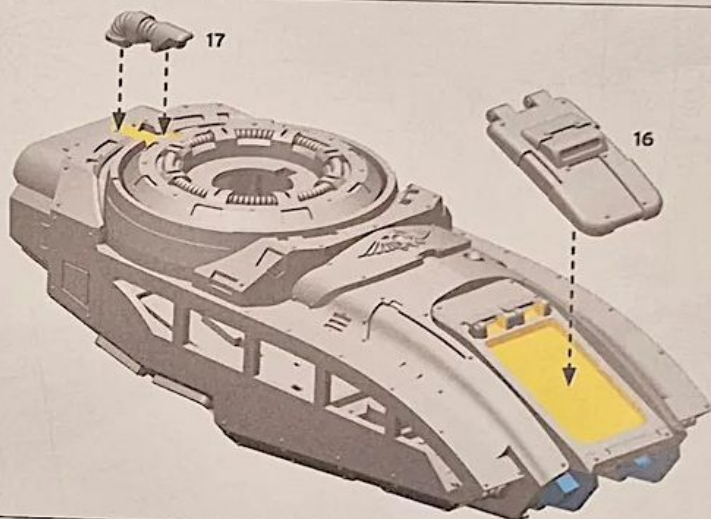

26C

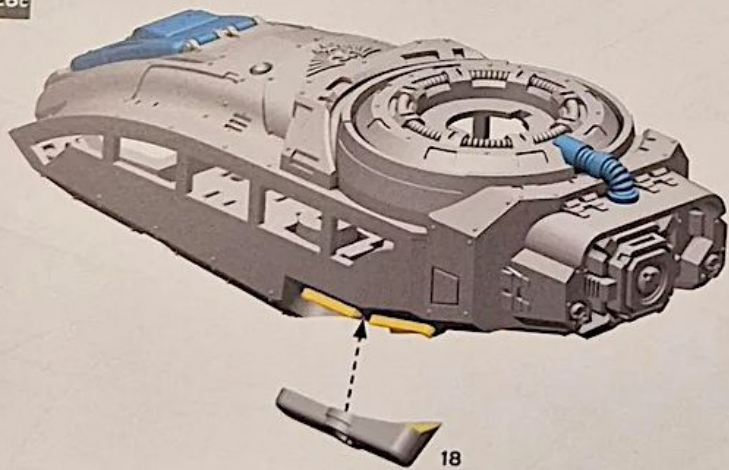

26D

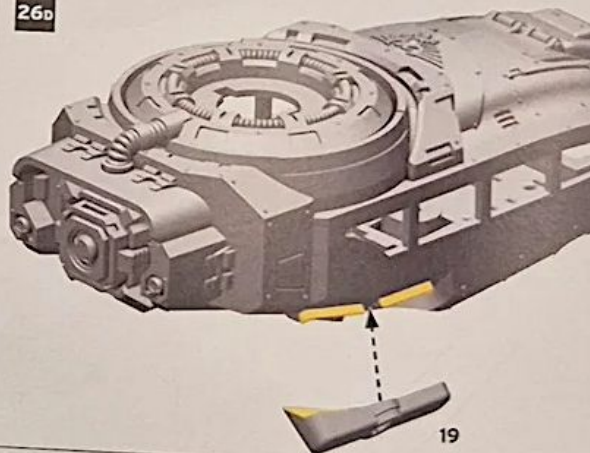

26E



26F



27A TWIN LASTRUM
BOLT CANNON



27b



27c



28A TWIN NEUTRONIUM
CASCADE PROJECTOR



28b



28c



29

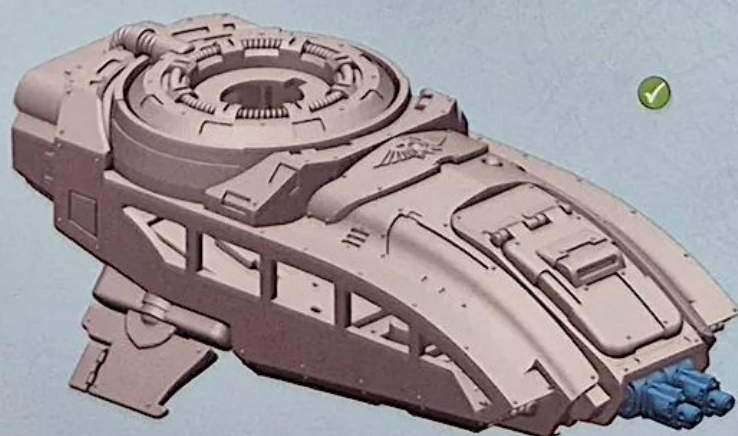
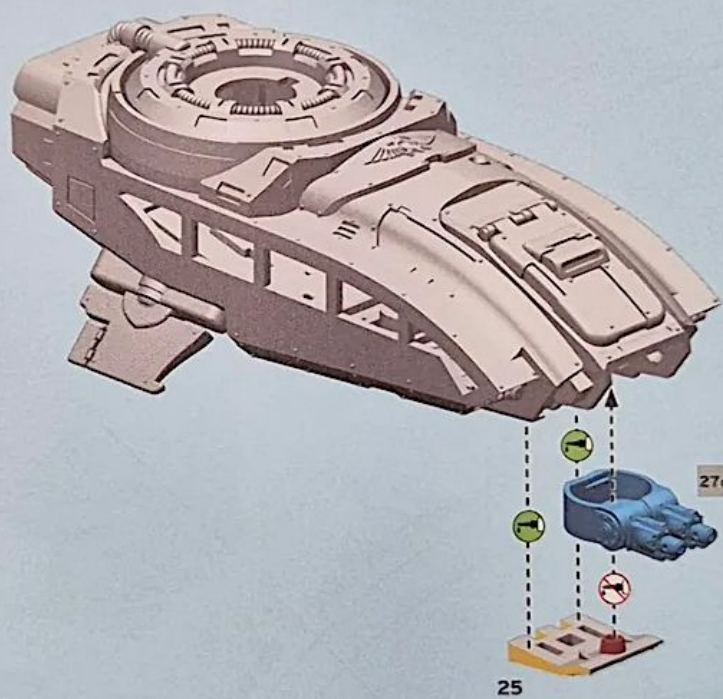

30A

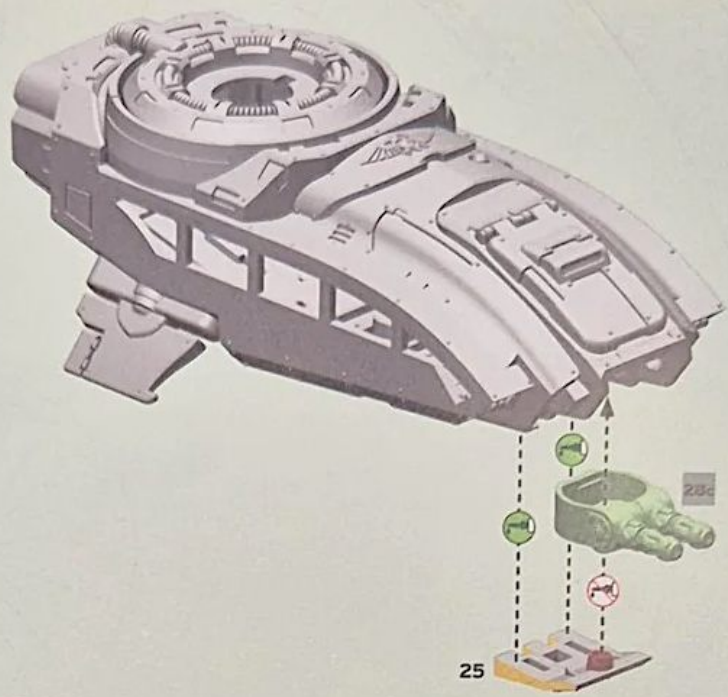

30B

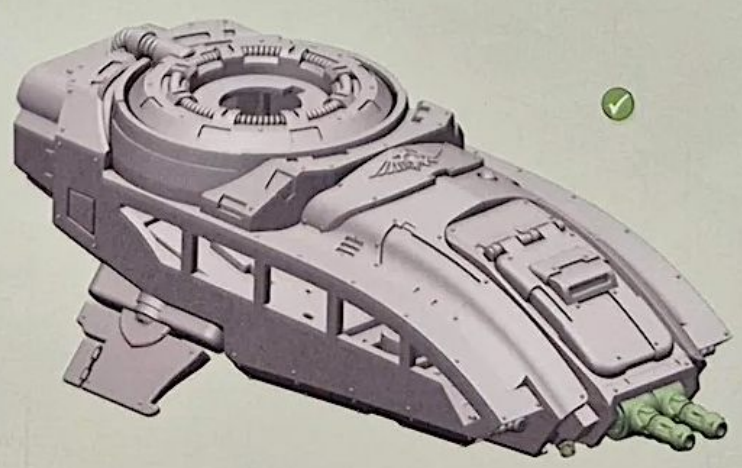
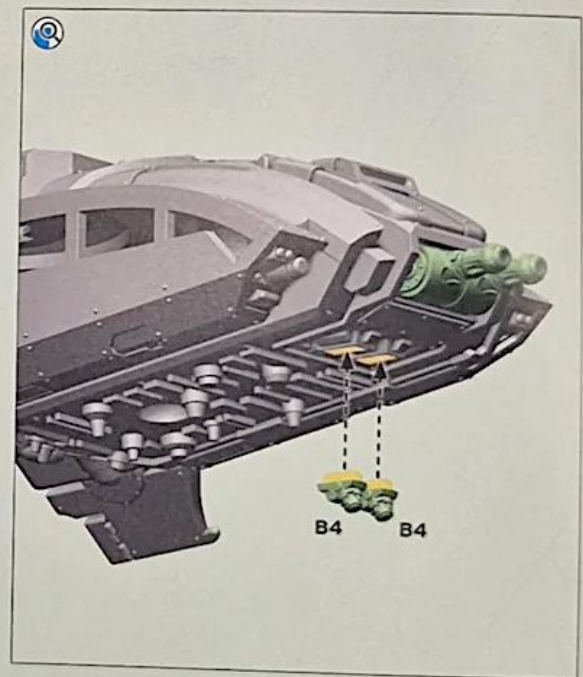
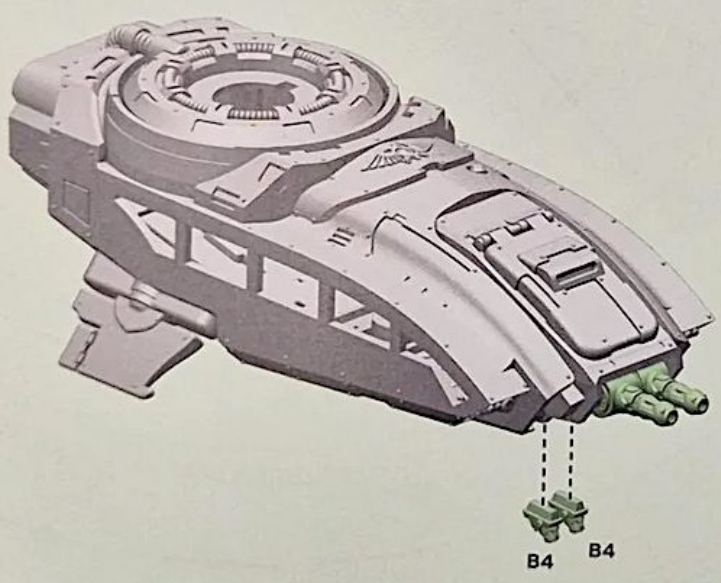

31A

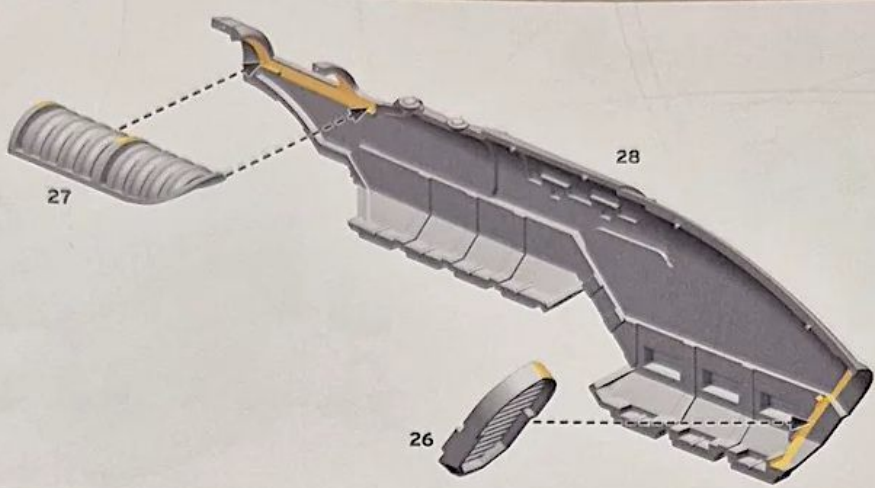

31B

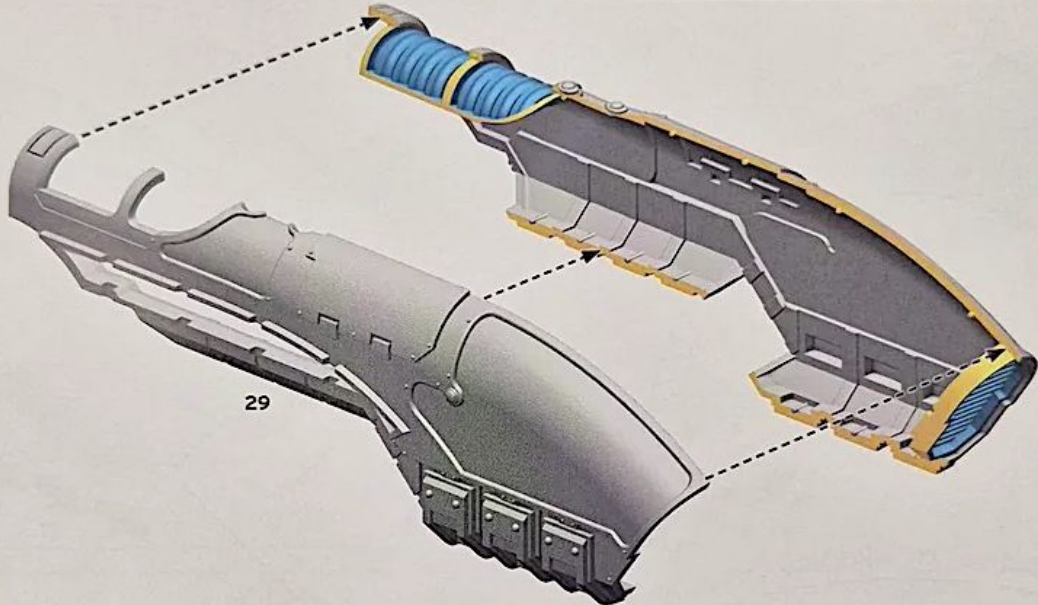

31C

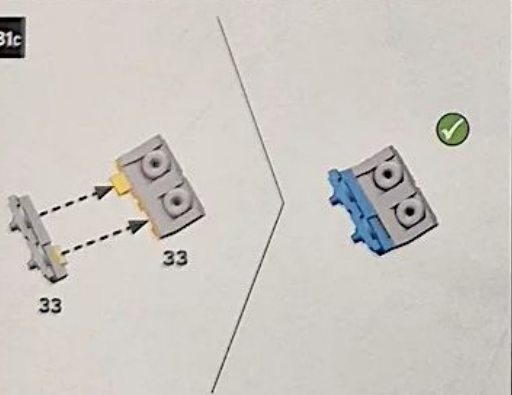

31D

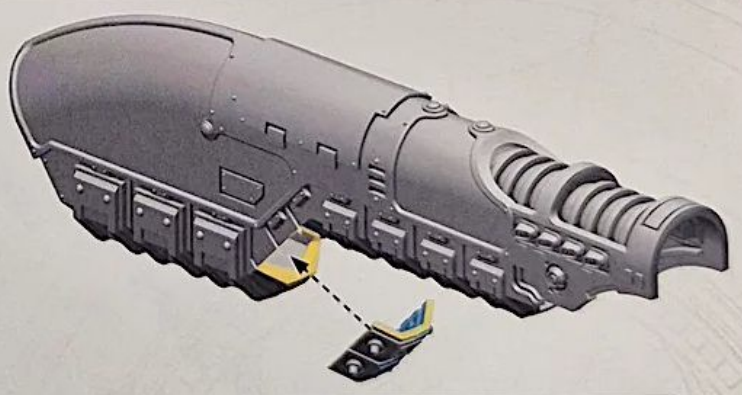

31E

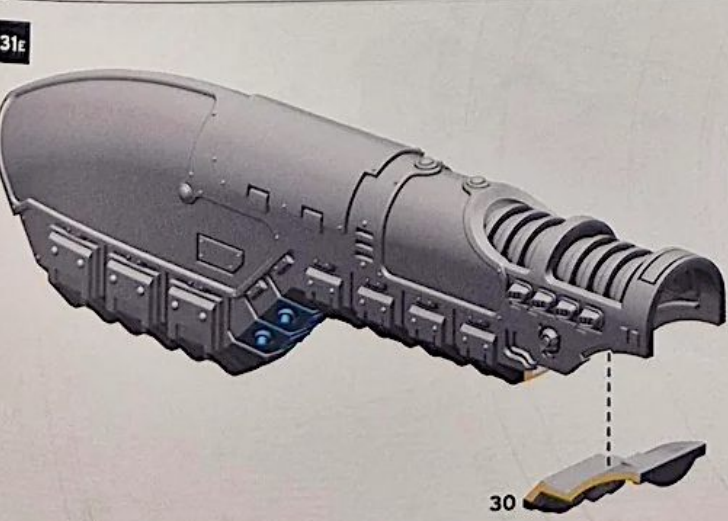

31F

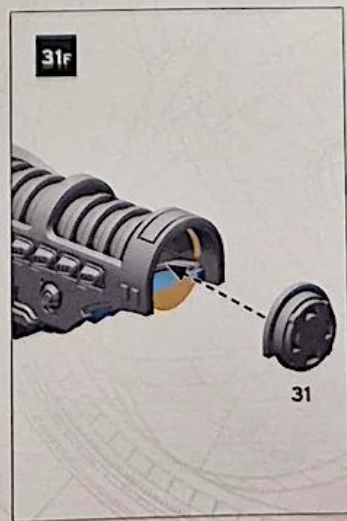

31G

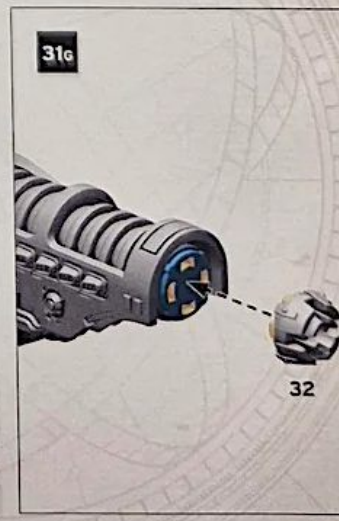

32a

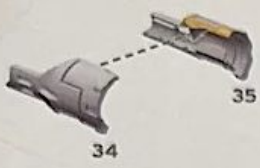

32b



32c



32d

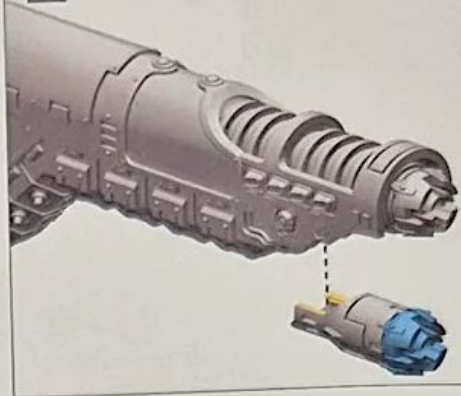

32e

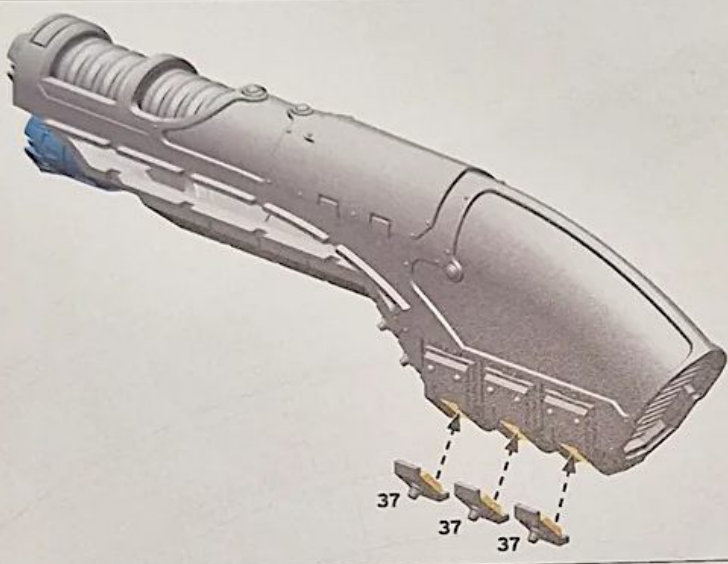

32f

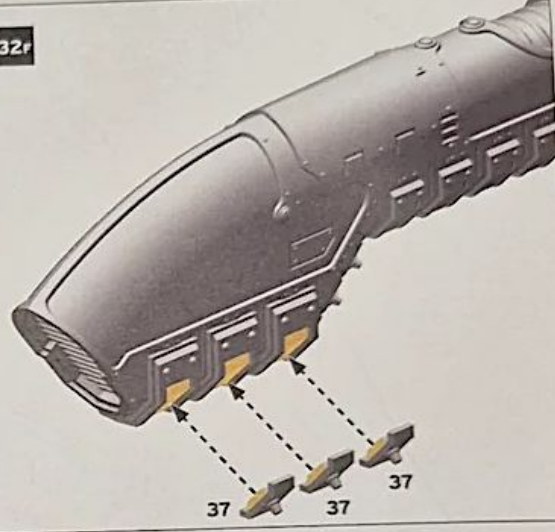

32g

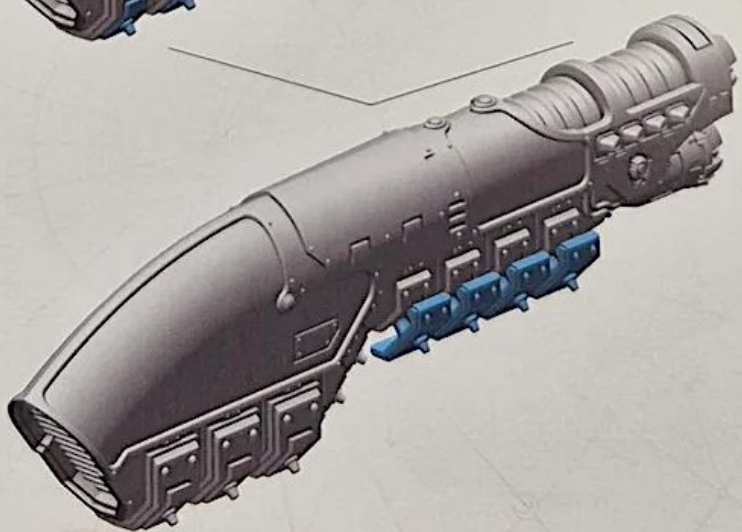
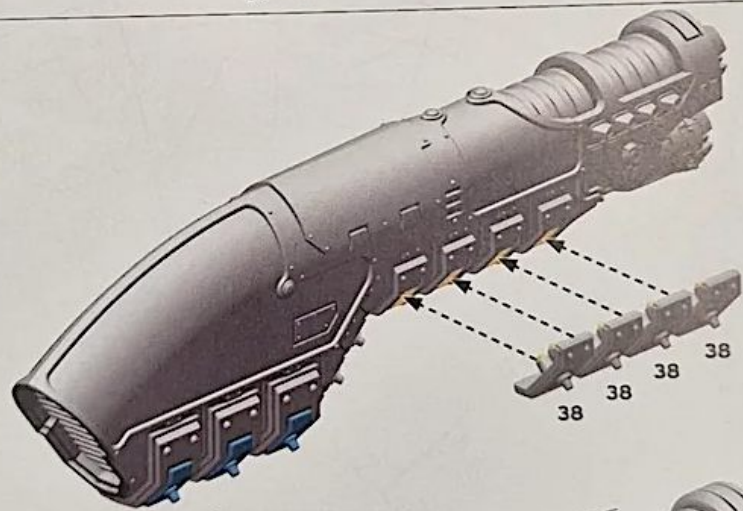

33a

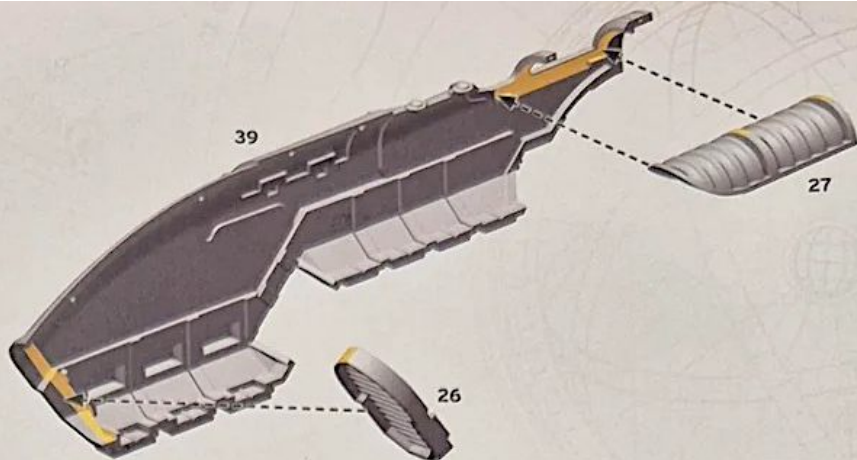

33b

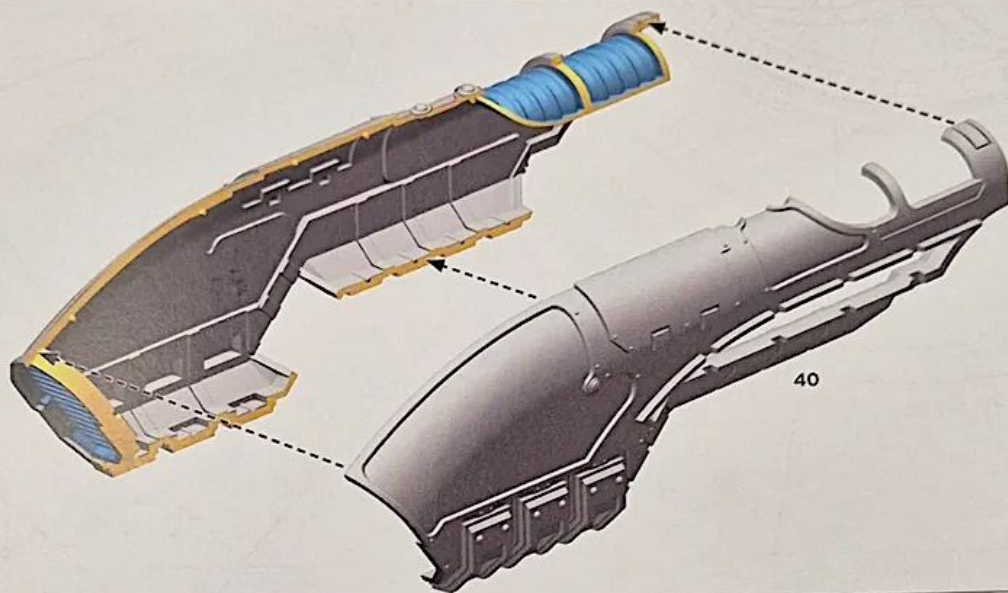

33c

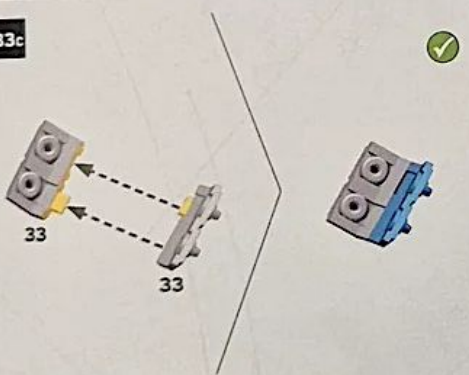

33d

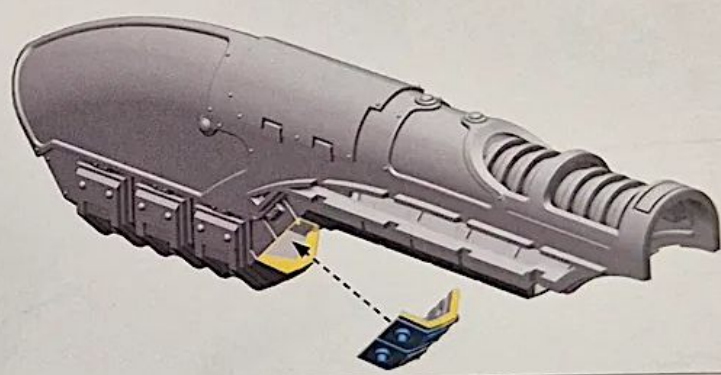

33e

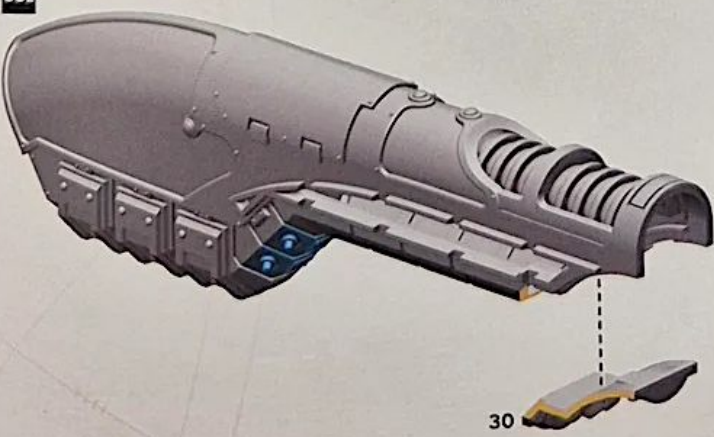

33f

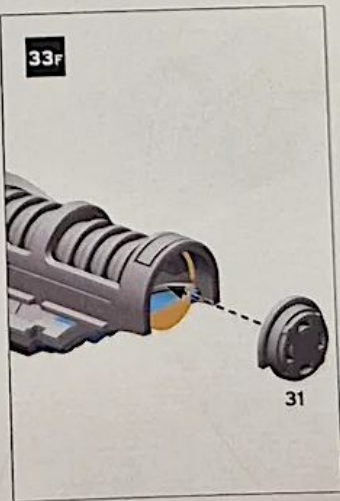

33g

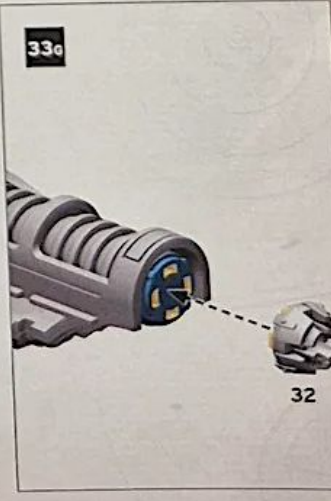

34a

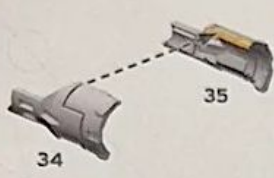

34b



34c

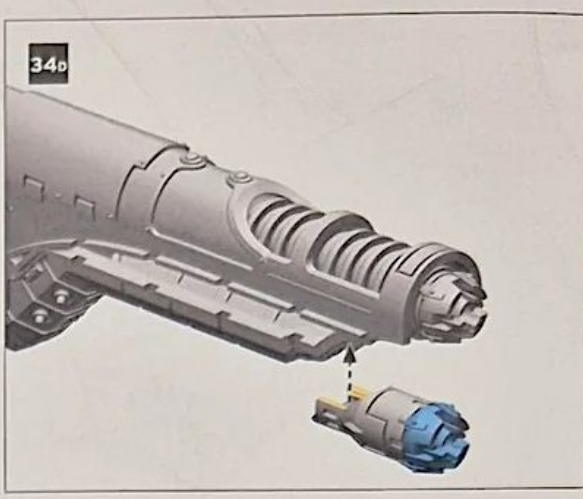

34e

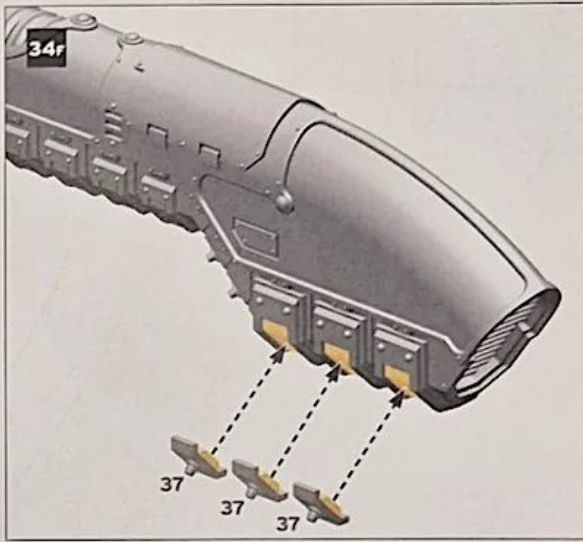
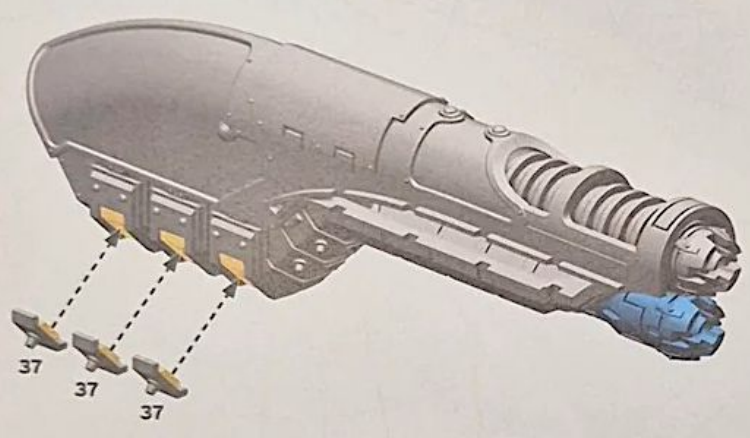

34g

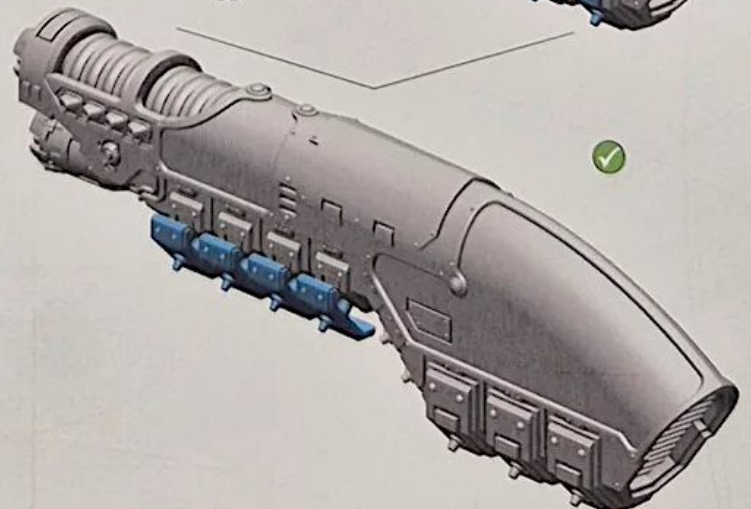
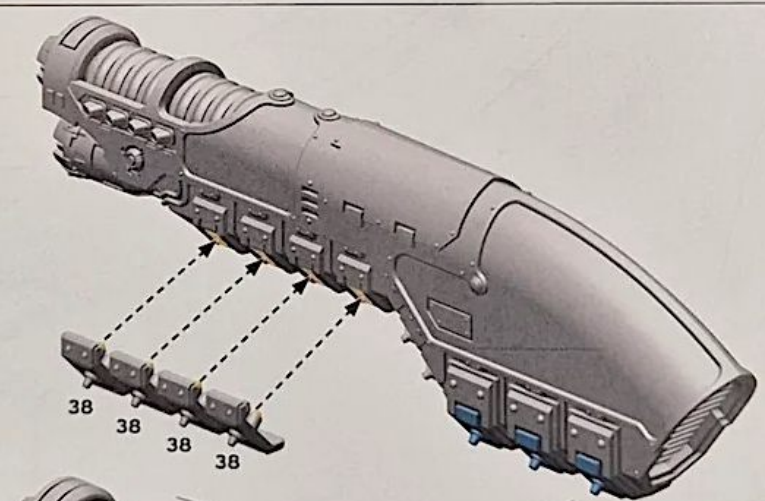

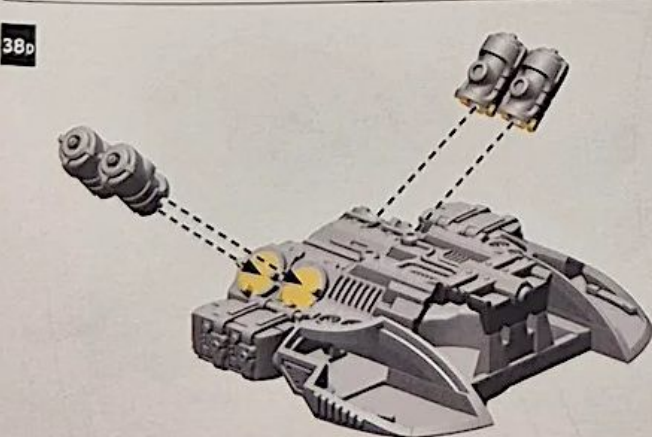
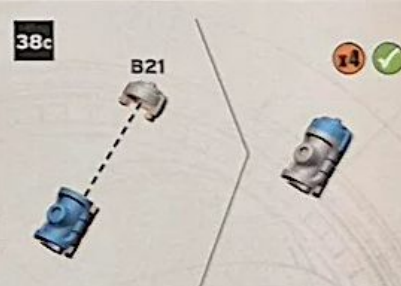
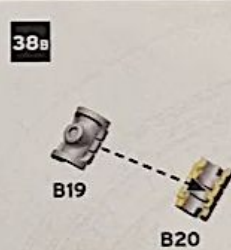
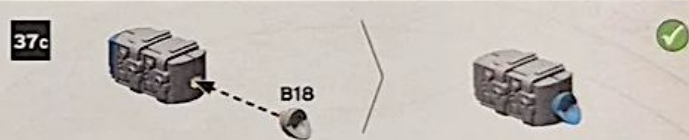
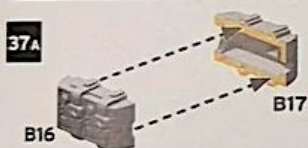
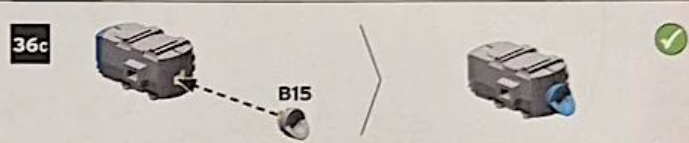
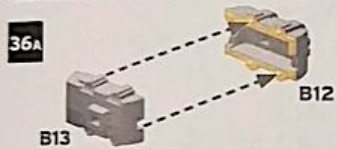
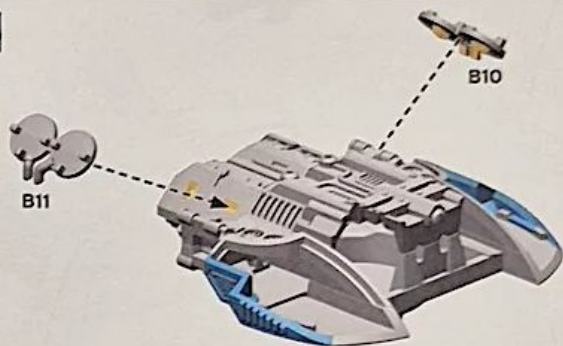
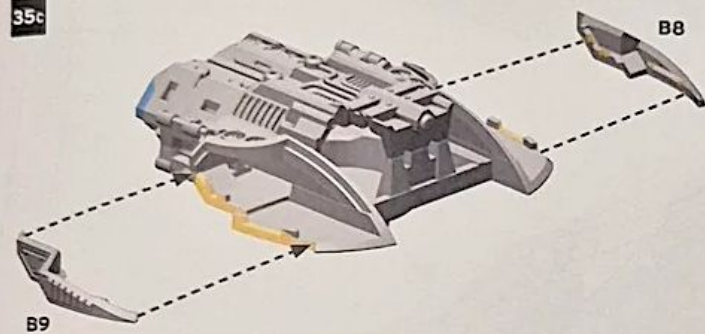
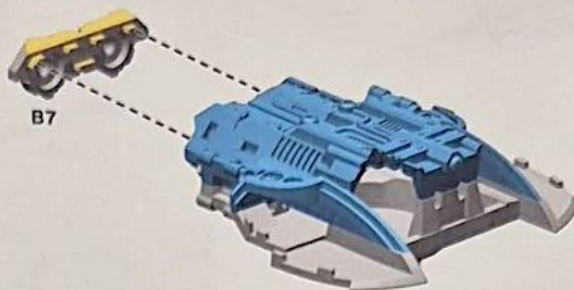
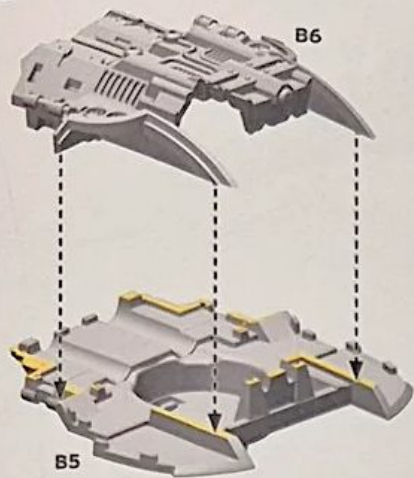

39A

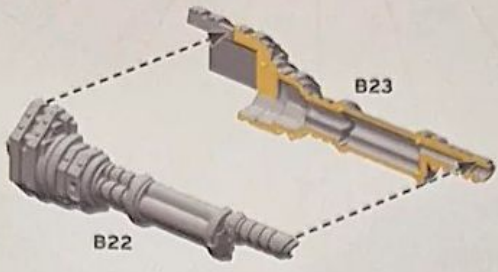

39B

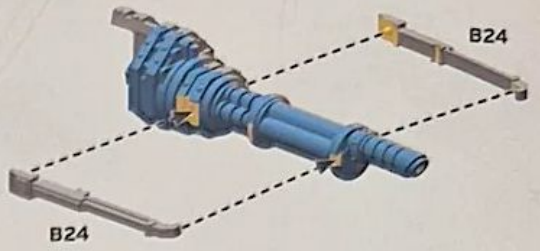

40A

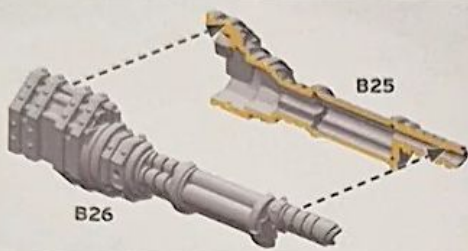

40B

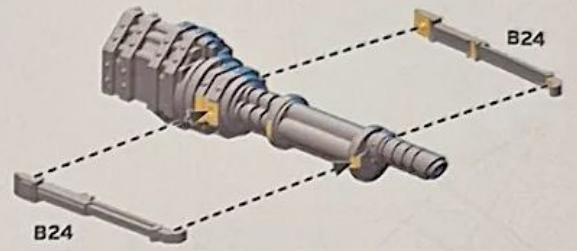

41A

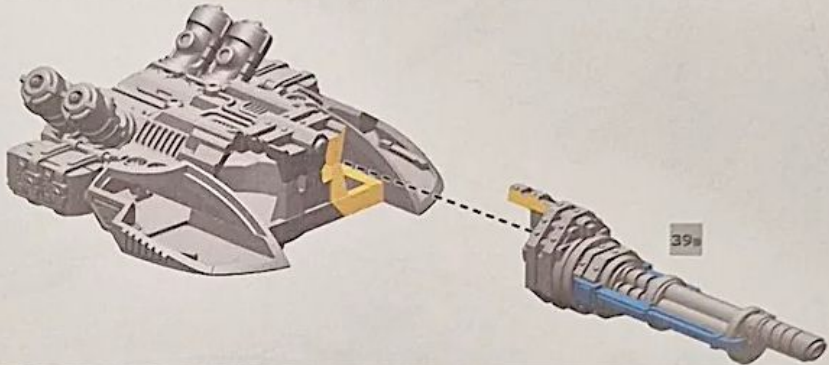

41B

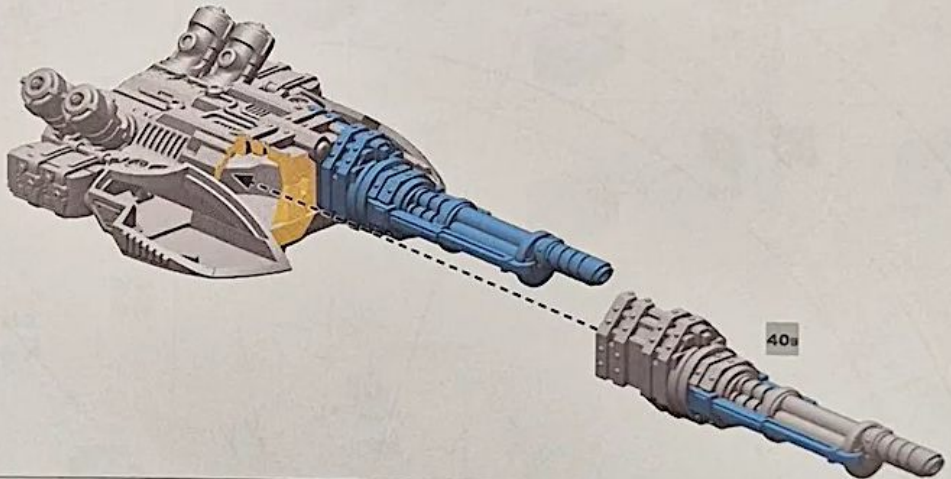

41c

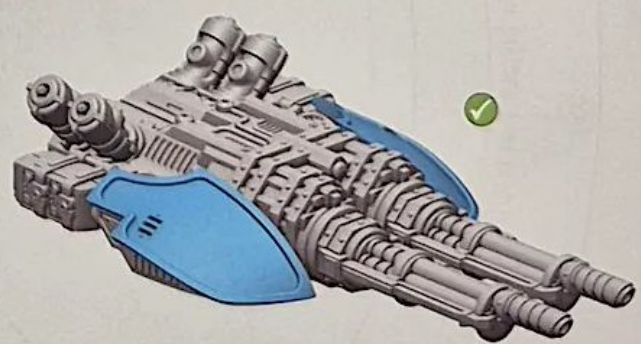
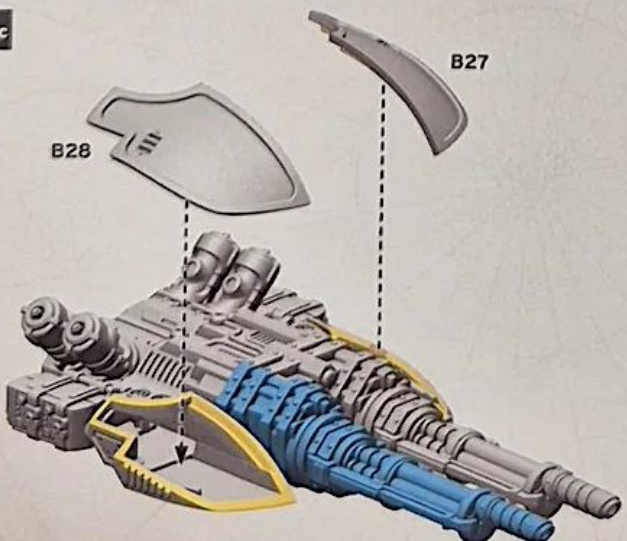

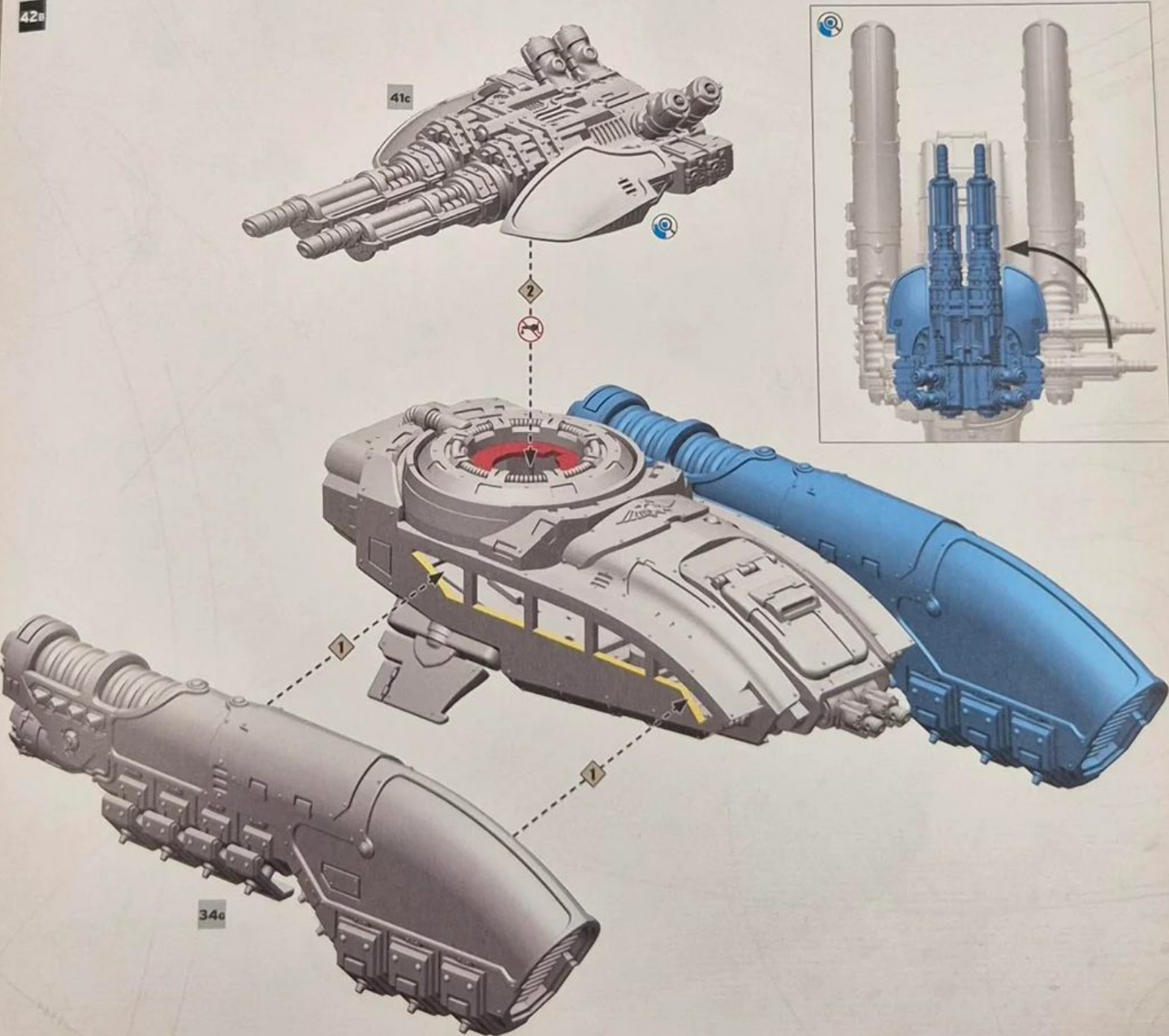
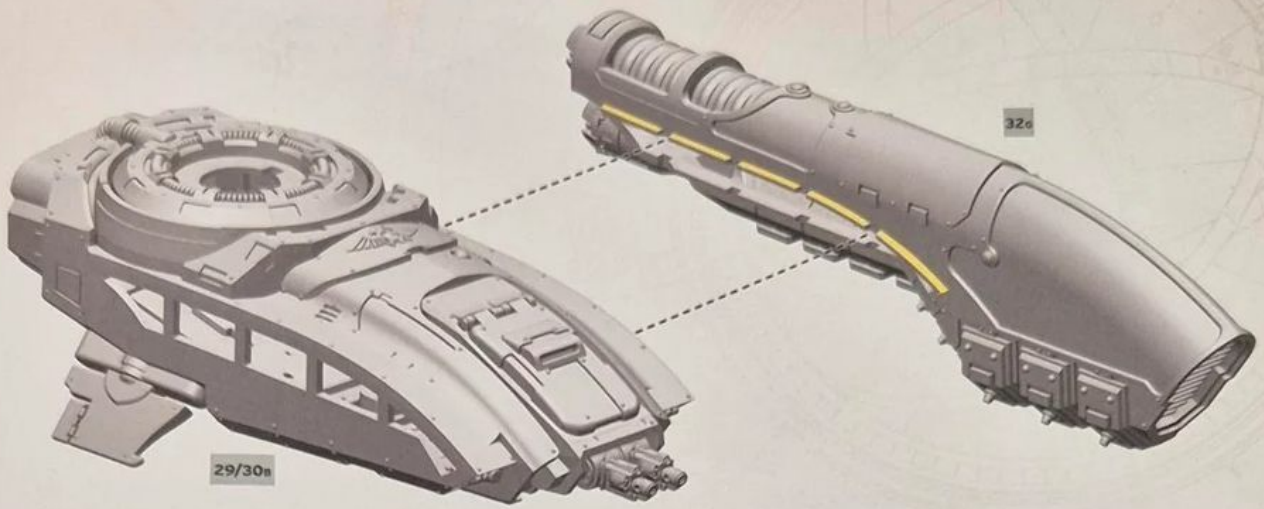

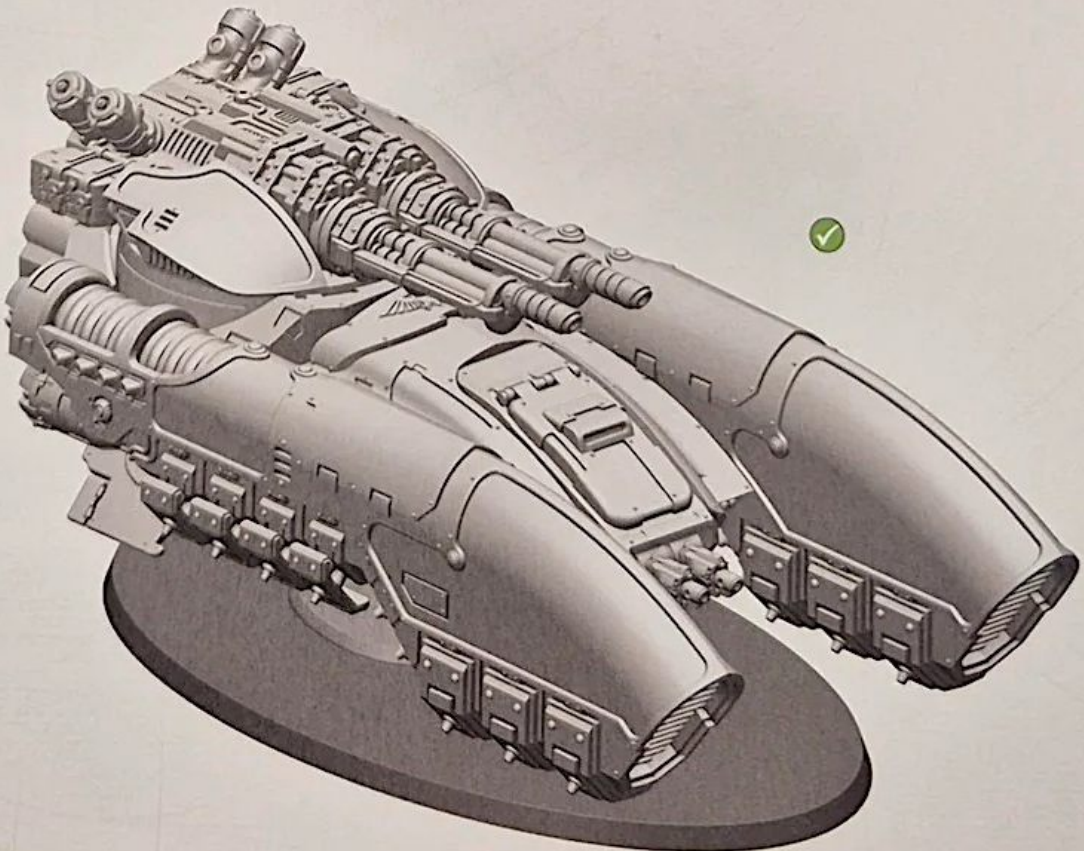
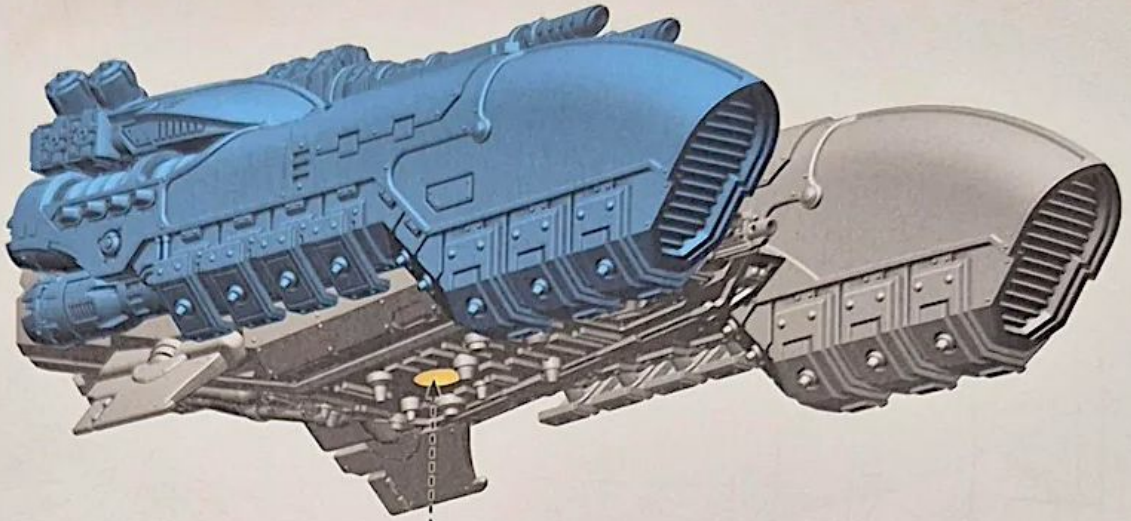

GALATUS AND ACHILLUS DREADNOUGHT



Choose the variant you want to build | Choisissez la variante à assembler | Elige qué versión quieres montar | Wähle die Variante, die du bauen möchtest
 Scegli la variante che vuoi assemblare | 組み立てバリエーションの選択 | 選擇你喜欢的拼装方式



CONTEMPTOR-GALATUS DREADNOUGHT



CONTEMPTOR-ACHILLUS DREADNOUGHT

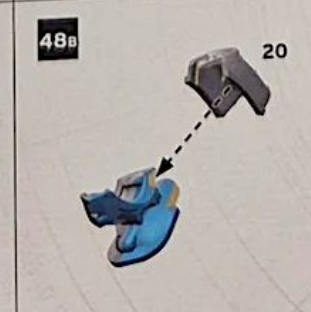
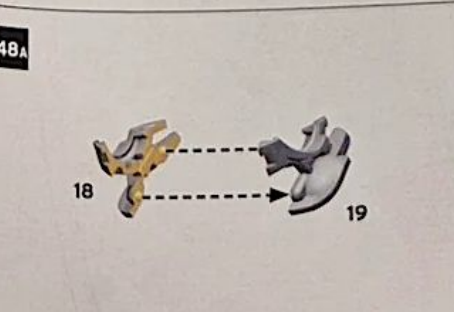
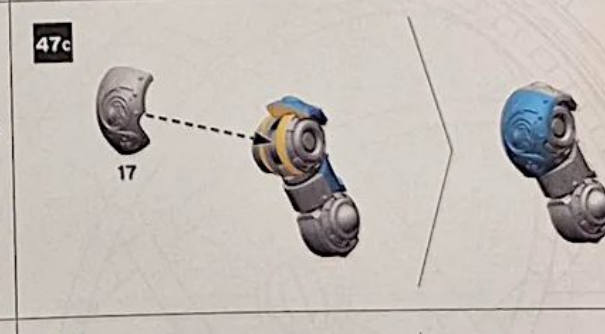
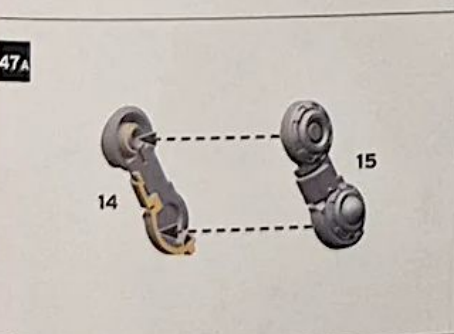
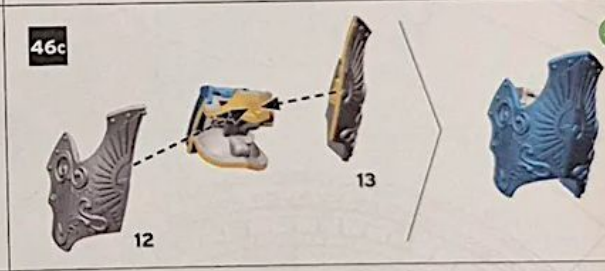
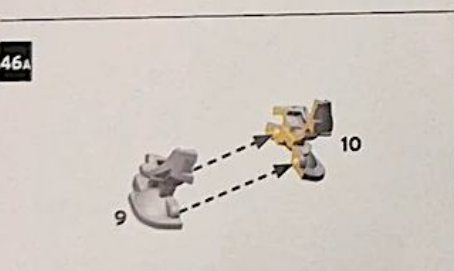
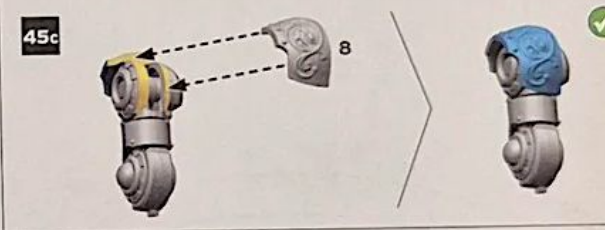
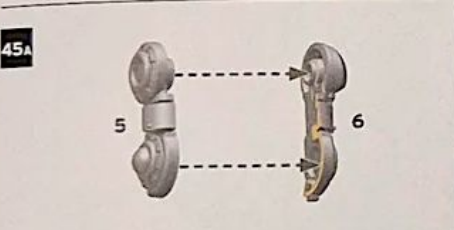
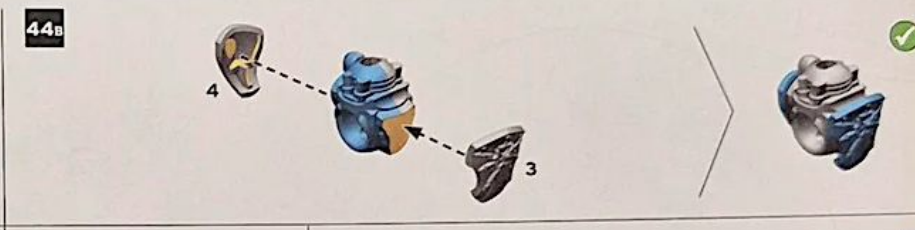
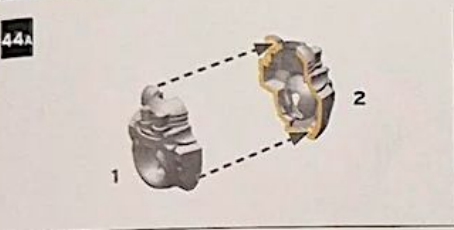

49A - 50F



51A - 52G



49A



49B



49C



49D



50A



50B



50C



50D



50E

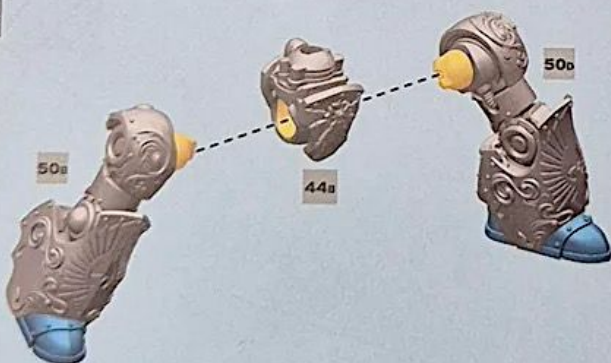

50F



51a

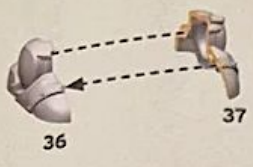

51b



51c

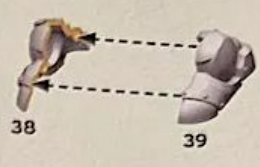

51d



52a



52b



52c

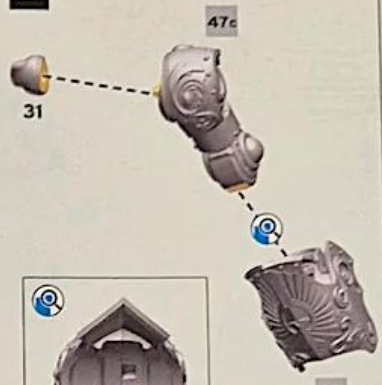

52d



52e



52f



52g



53a



53b

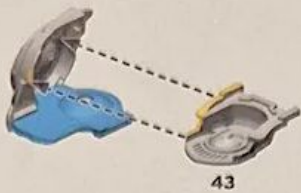

53c

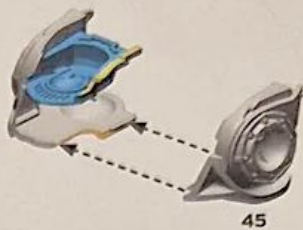

53d



53e



53f

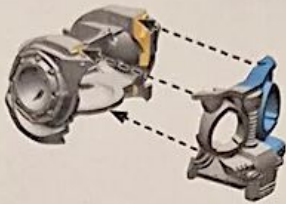

53g

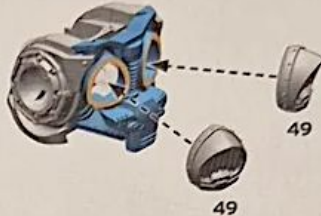

53h



53i

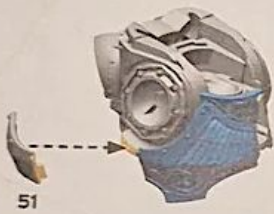

53j

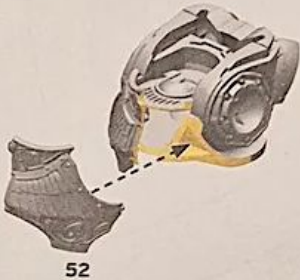

53k



53l



54a



54b



55

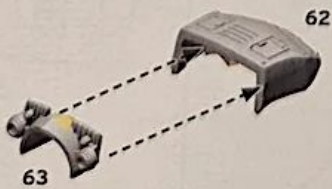

56A - 57D



58A - 59D



56A

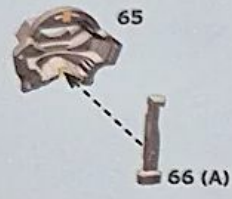

56B



56C



56D



56E



57A



57B



57C



57D



58A



58B



58C



58D



58E



59A



59B



59C



59D



