



Free Downloads of Build Instructions,
Assembly Booklets & How To Guides

BuildInstructions.com

WARHAMMER THE HORUS HERESY

LEGIO CUSTODES CUSTODIAN DREADNOUGHT

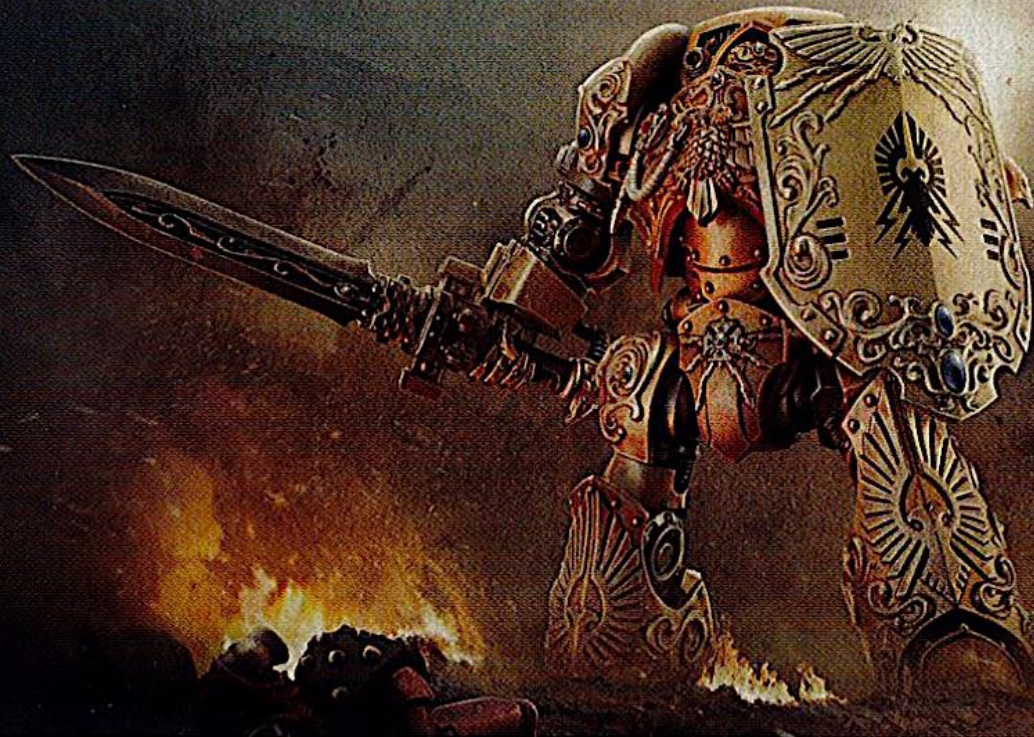

READ THIS FIRST | À LIRE EN PRIORITÉ | BITTE BEACHT E | LEE ESTO PRIMERO | LEGGI PRIMA QUESTO | 最初にお読みください。| 请优先阅读

ENG BEFORE ASSEMBLING YOUR MINIATURES, PLEASE READ THROUGH THE INSTRUCTIONS IN THIS BOOKLET CAREFULLY.

A pair of plastic cutters is required to remove the plastic components in this kit from their frame. We advise using a mouldline scraping tool to clean up the parts. To assemble your model you will need plastic glue. Games Workshop sells Citadel Fine Detail Cutters, Citadel Mouldline Removers and Citadel Plastic Glue, but does not recommend these products for use by children under the age of 16 without adult supervision.

FRE AVANT D'ASSEMBLER VOS FIGURINES, VEUILLEZ LIRE ATTENTIVEMENT LES INSTRUCTIONS DE CE LIVRET.

Une pince coupante est requise pour détacher chaque élément de sa grappe plastique. Nous vous recommandons l'utilisation d'un ébarboir pour gratter chaque élément. Pour l'assemblage, vous aurez besoin de colle plastique. Games Workshop commercialise les Pinces de Précision Citadel, l'Ébarboir Citadel et la Colle Plastique Citadel, mais n'en recommande pas l'utilisation aux enfants de moins de 16 ans sans la supervision d'un adulte.

SPA POR FAVOR, LEE CUIDADOSAMENTE ESTE LIBRETO DE INSTRUCCIONES ANTES DE EMPEZAR A MONTAR LAS MINIATURAS.

Te harán falta unas tenazas para plástico a fin de separar las piezas de la matriz. También aconsejamos una herramienta para quitar rebabas a fin de limpiar cada pieza. Para montar la miniatura necesitarás pegamento para plástico. Games Workshop vende Tenazas de detalle superfino, Quitarrebabas Citadel y Pegamento para plástico Citadel, pero no recomienda estos productos a menores de 16 años sin supervisión de un adulto.

GER VOR DEM ZUSAMMENBAU DER MINIATUREN BITTE DIE ANWEISUNGEN IN DIESER ANLEITUNG AUFMERKSAM DURCHLESEN.

Du benötigst einen Kunststoffseitenschneider, um die Kunststoffbauteile aus dem Gussrahmen herauszutrennen. Außerdem empfehlen wir, die Bauteile mit einem Gussgratentferner zu säubern. Um dein Modell zusammenzubauen, benötigst du Kunststoffkleber. Games Workshop bietet Präzisions-Seitenschneider und Gussgratentferner von Citadel sowie Citadel-Kunststoffkleber an, empfiehlt aber, dass Kinder unter 16 Jahren diese nur unter Aufsicht eines Erwachsenen benutzen.

ITA PRIMA DI ASSEMBLARE LE TUE MINIATURE LEGGI ATTENTAMENTE TUTTE LE ISTRUZIONI DI QUESTO LIBRETTO.

Sono necessarie un paio di tronchesine per plastica per staccare i componenti dal loro sprue. Consigliamo di usare un attrezzo apposito per pulire i componenti. Per assemblare il modello avrai bisogno di colla per plastica. Games Workshop vende Tronchesine di ultraprecisione Citadel, Attrezzo per ripulire Citadel e Colla per plastica Citadel, ma non consiglia questi prodotti ad un pubblico minore di 16 anni senza la supervisione di un adulto.

中国 开始前请务必仔细阅读本说明书。

本套件内的フレームからプラスチックパーツを切り離すためには、ニッパーが必要です。パーツのモールドを平らにするには、専用ツールの使用をお勧めいたします。本キットの組み立てには、プラ用接着剤が必要です。ゲームワークショップはスーパー・ファインディテール・カッター、シタデル・プラスチックグルー、シタデル・モールドラインリムーバーを販売しておりますが、16歳以下の子供が大人の監督なしにこれらの道具を使用されることをお勧めしません。

中文 在组装您的微缩模型之前，请仔细阅读本手册中的说明。

您需要一把模型剪将塑料部件从板件上剪下来。我们建议使用模线刮刀来处理零件。组装时你还需要用到塑料胶水。你可以从 Games Workshop 处购买到 Citadel 精密剪钳、Citadel 模线刮刀和 Citadel 塑料胶水，但 16 岁以下儿童不得在没有成年人监护的情况下使用这些产品。

EXPLANATION OF SYMBOLS | EXPLICATION DES SYMBOLES | EXPLICACIÓN DE SÍMBOLOS
 ERLÄUTERUNG DER SYMBOLE | LEGENDA DEI SIMBOLI | アイコン解説 | 符号説明



- Detail view
- Vue détaillée
- Vista detallada
- Alternative Ansicht
- Visuale del dettaglio
- 拡大
- 局部放大视图



- Choice of parts
- Choix d'éléments
- Piezas opcionales
- Auswahl an Teilen
- Scelta di componenti
- パーツの選択
- 选择部件



- Variant assembly
- Variante d'assemblage
- Variante de montaje
- Bauvariante
- Assemblaggio alternativo
- 組み立てバリエーション
- 多种组装方式



- Dry fit stage before gluing
- Tester avant de coller
- Comprobar el encaje antes de pegar
- Positionierung erst ohne Klebstoff ausprobieren
- Prova a secco prima di incollare
- 接着前にぴったり合わせること
- 粘接前的假组阶段



- Stage complete
- Étape terminée
- Paso completado
- Schritt abgeschlossen
- Fase completa
- このステージの完成
- 完成

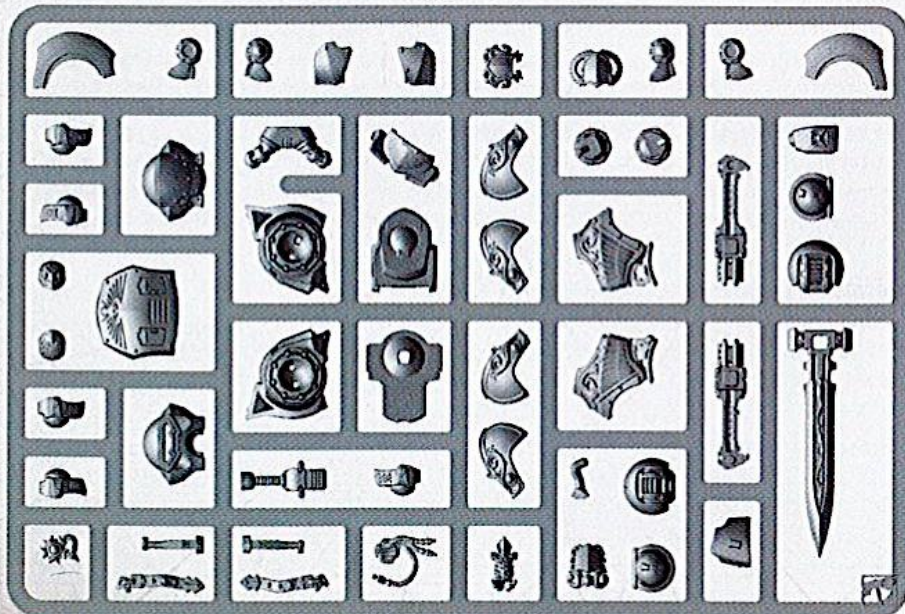
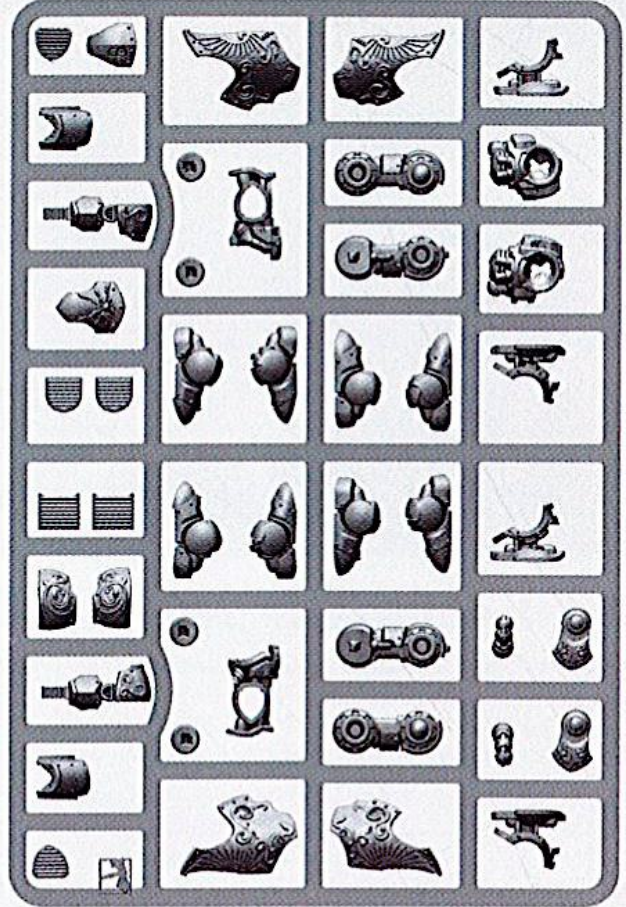
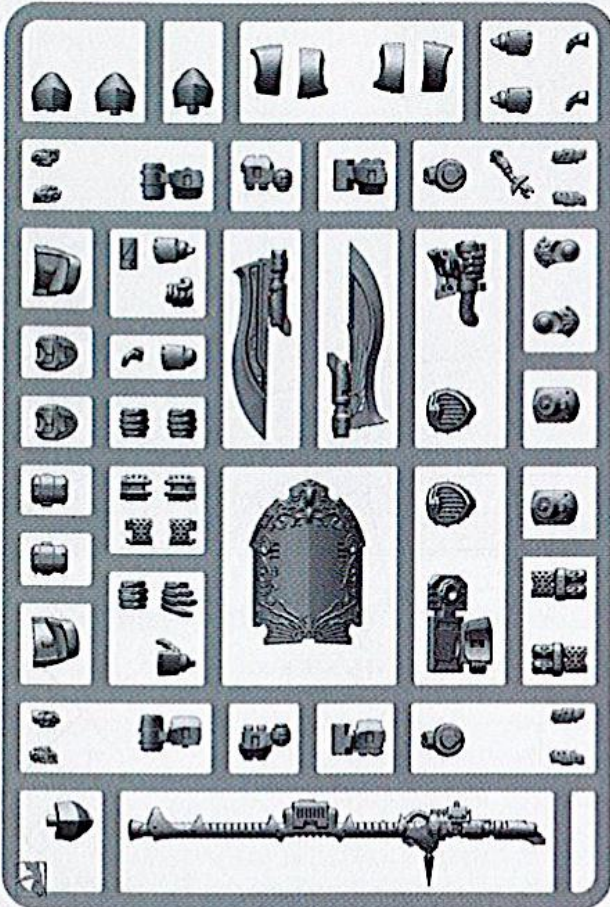

60mm x1

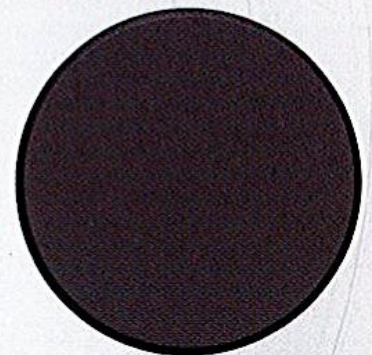

**CONTEMPTOR-
GALATUS**



**CONTEMPTOR-
ACHILLUS**

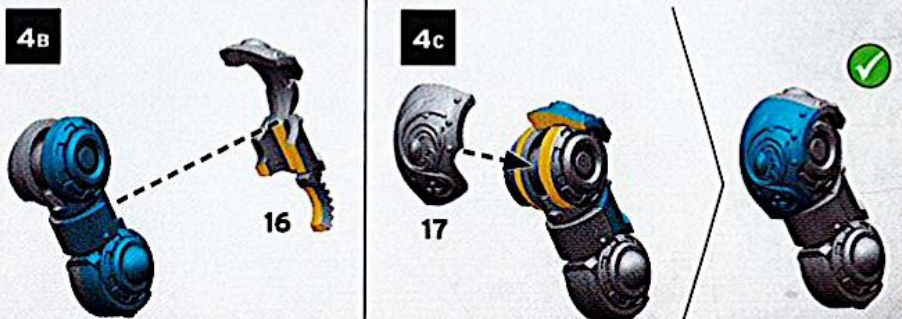
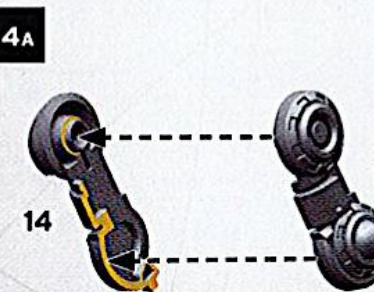
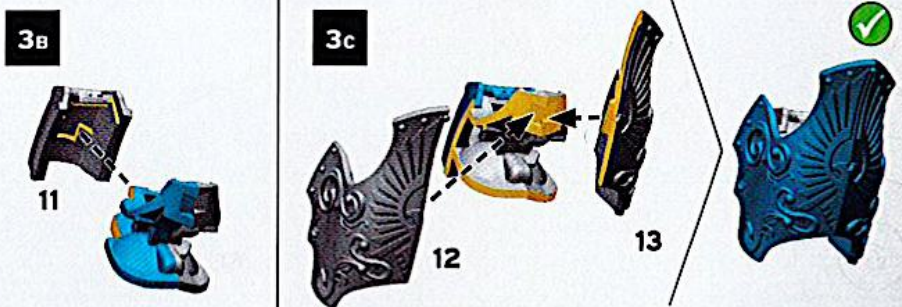
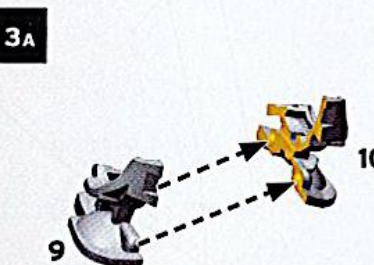
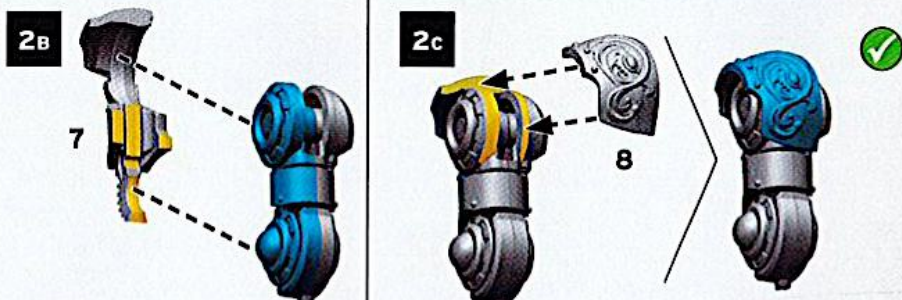
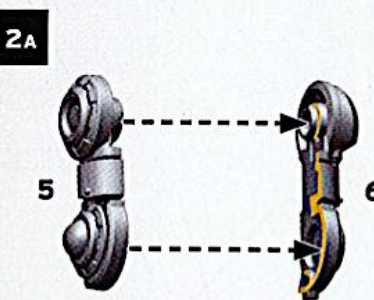
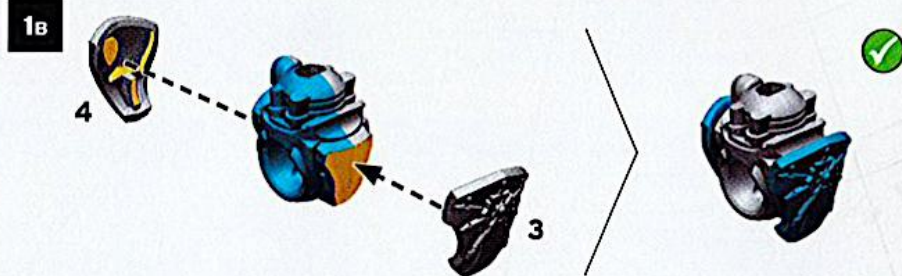
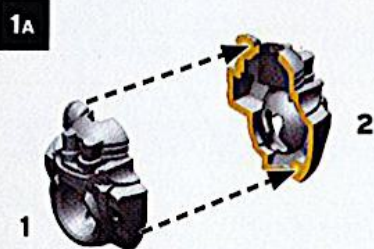

5A

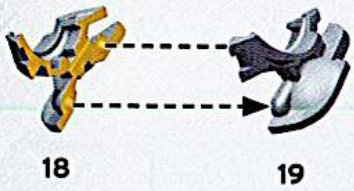

5B



5c



6A - 7F



8A - 10F



6A



6B

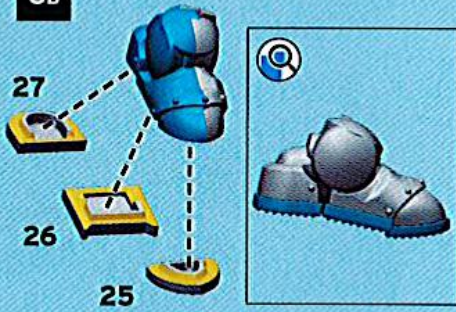

6c

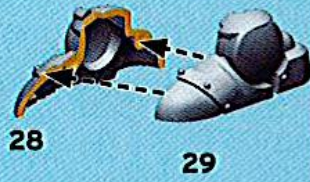

6d



7A



7B



7c



7d



7E



7D



7F



✓



8A

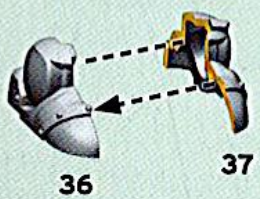

8B

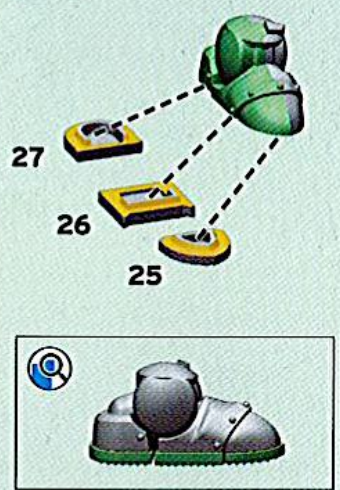

8C

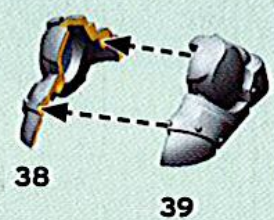

8D

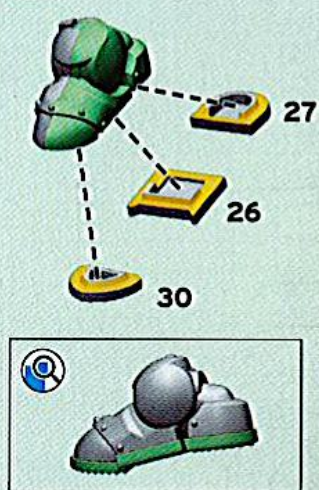

9

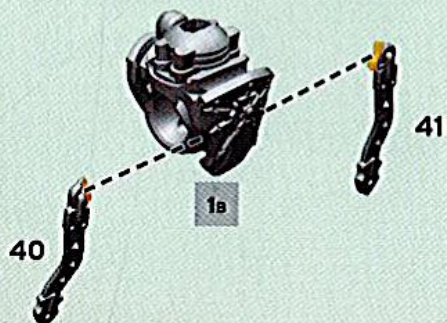

✓



10A

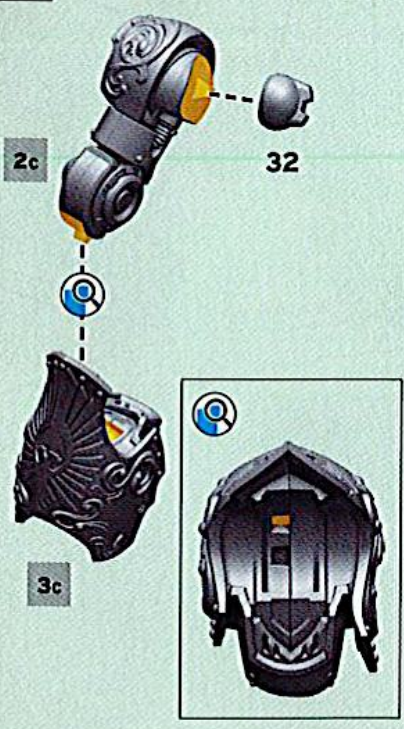

10B



10c



10d



10E

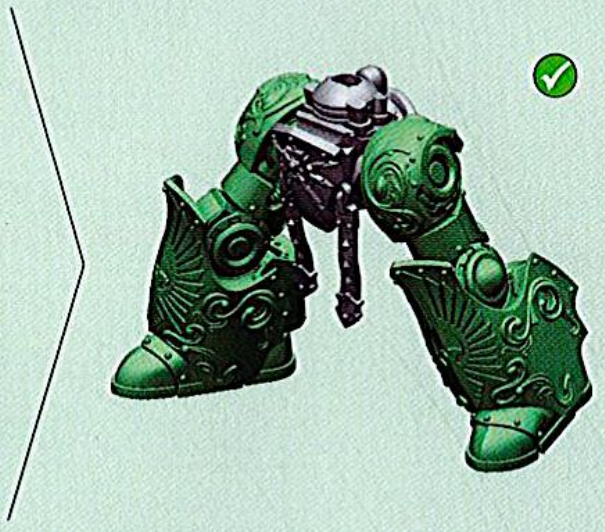

10F

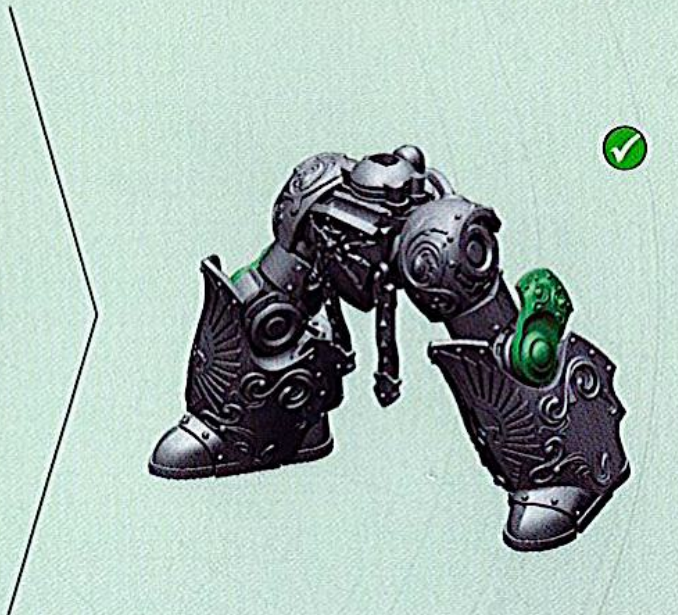

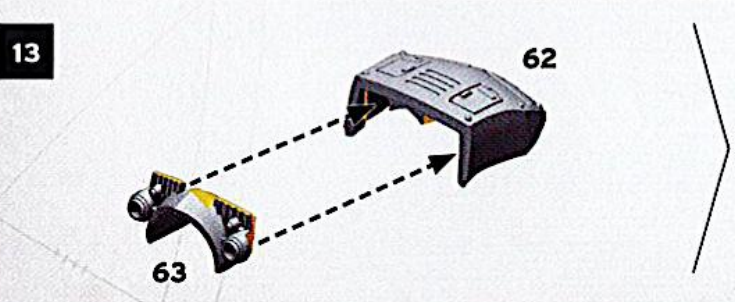
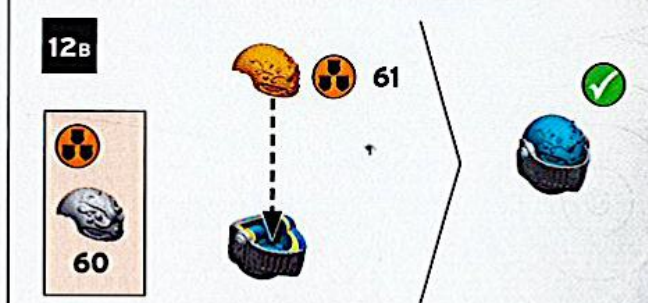
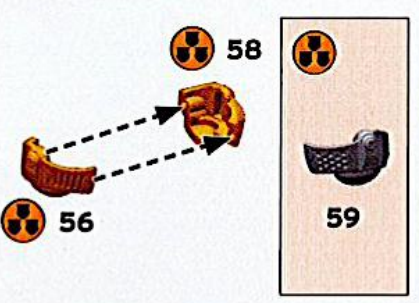
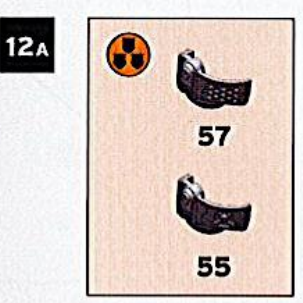
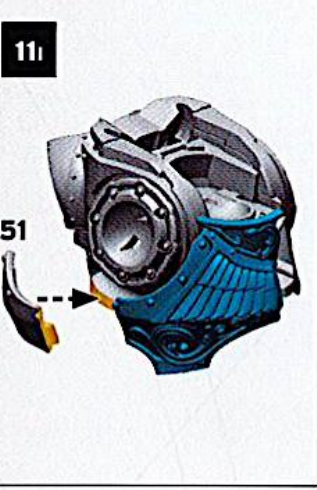
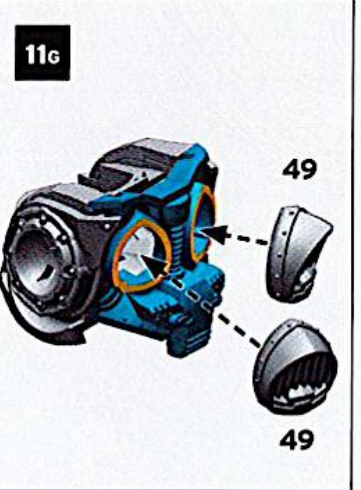
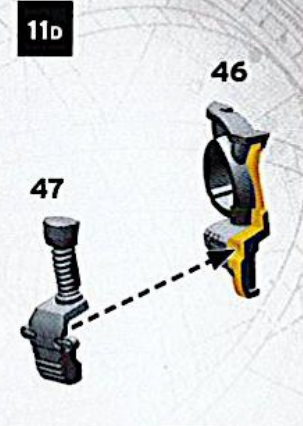
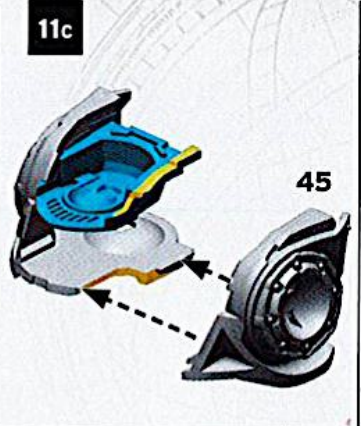
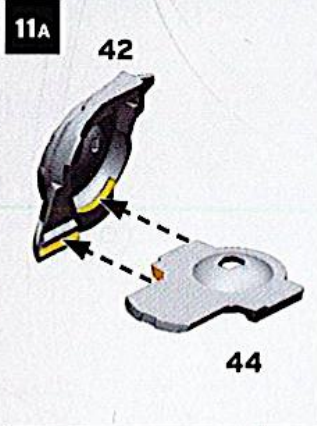

14A - 15D



16A - 17D



14A



14B



14C



14D



14E



15A



15B



15c



15d



16A

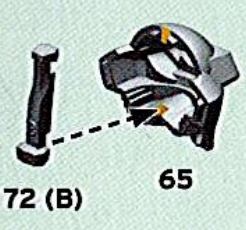

16B

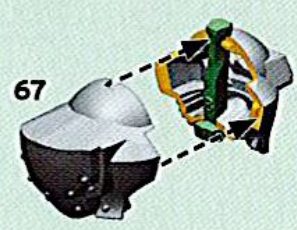

16c



16d



16E



17A



17B



17c



17d



18



19

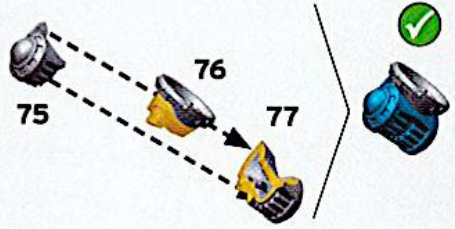

20

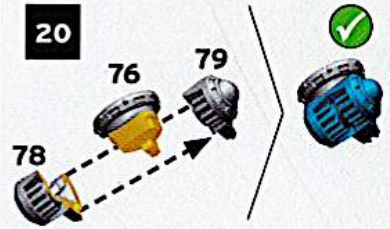

21

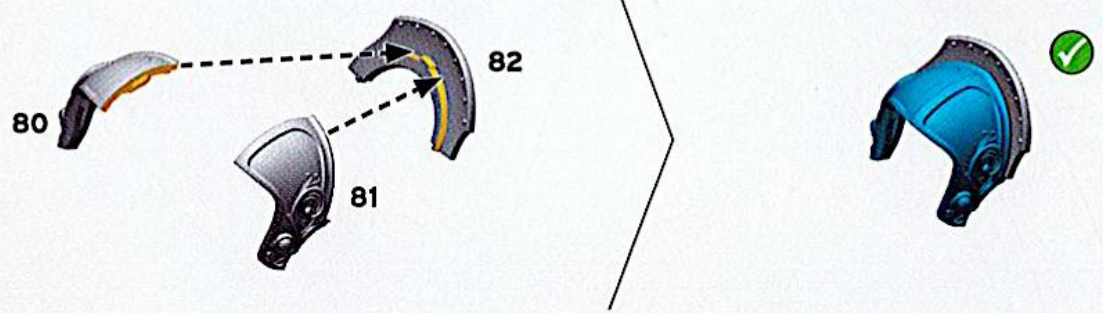

22A

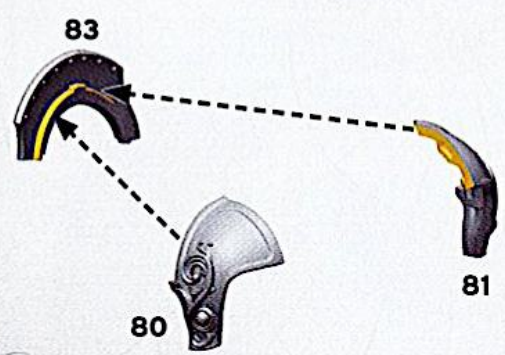

22B

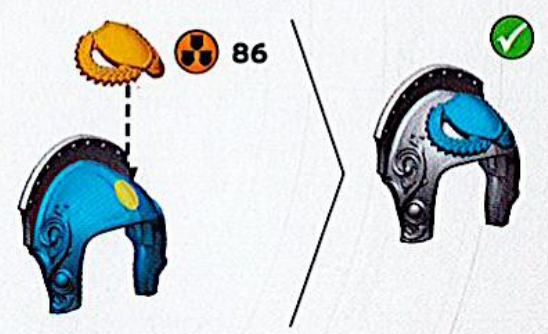
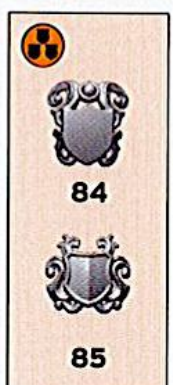

23A - 28D

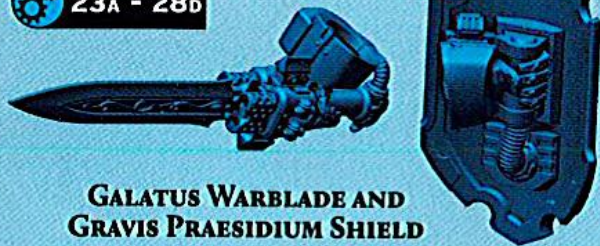

GALATUS WARBLADE AND GRAVIS PRAESIDIUM SHIELD

29A - 37D

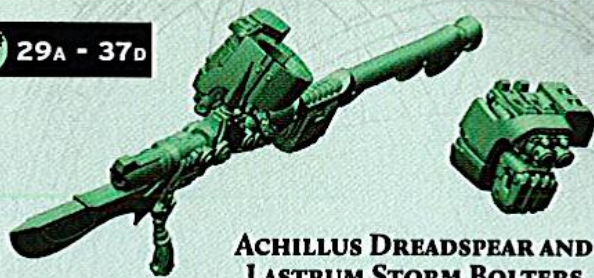

ACHILLUS DREADSPEAR AND LASTRUM STORM BOLTERS

23A



23B

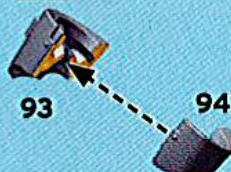

23C



23D



24A



24B



24C

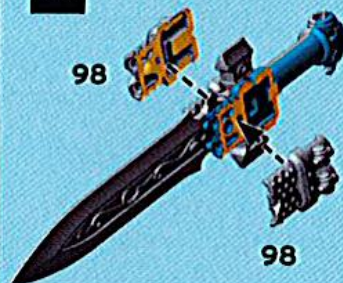

24D

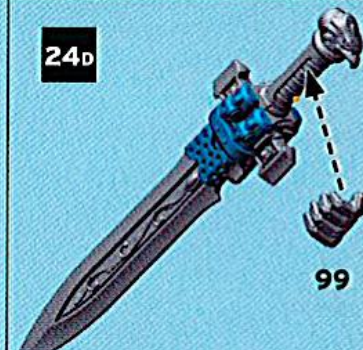

24E

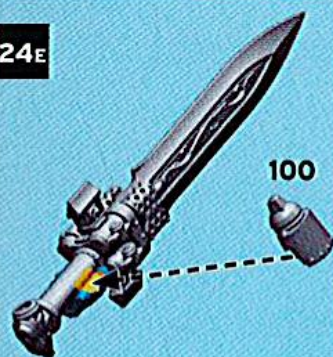

24F

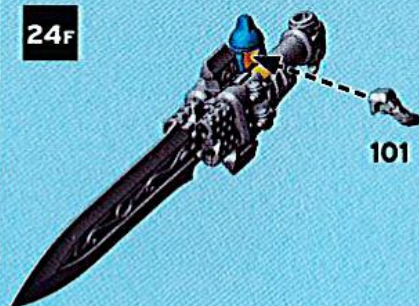

24G

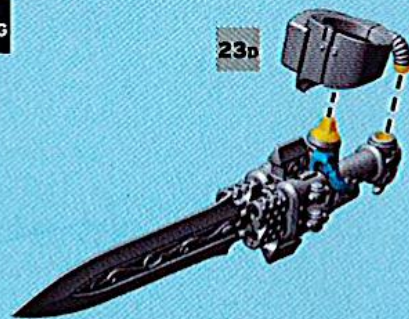

25A

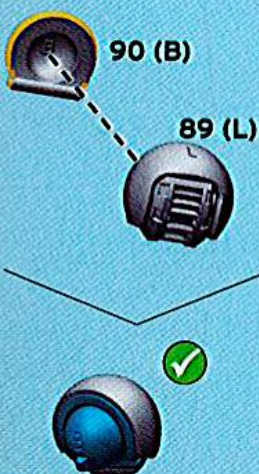

25B



25C



25D



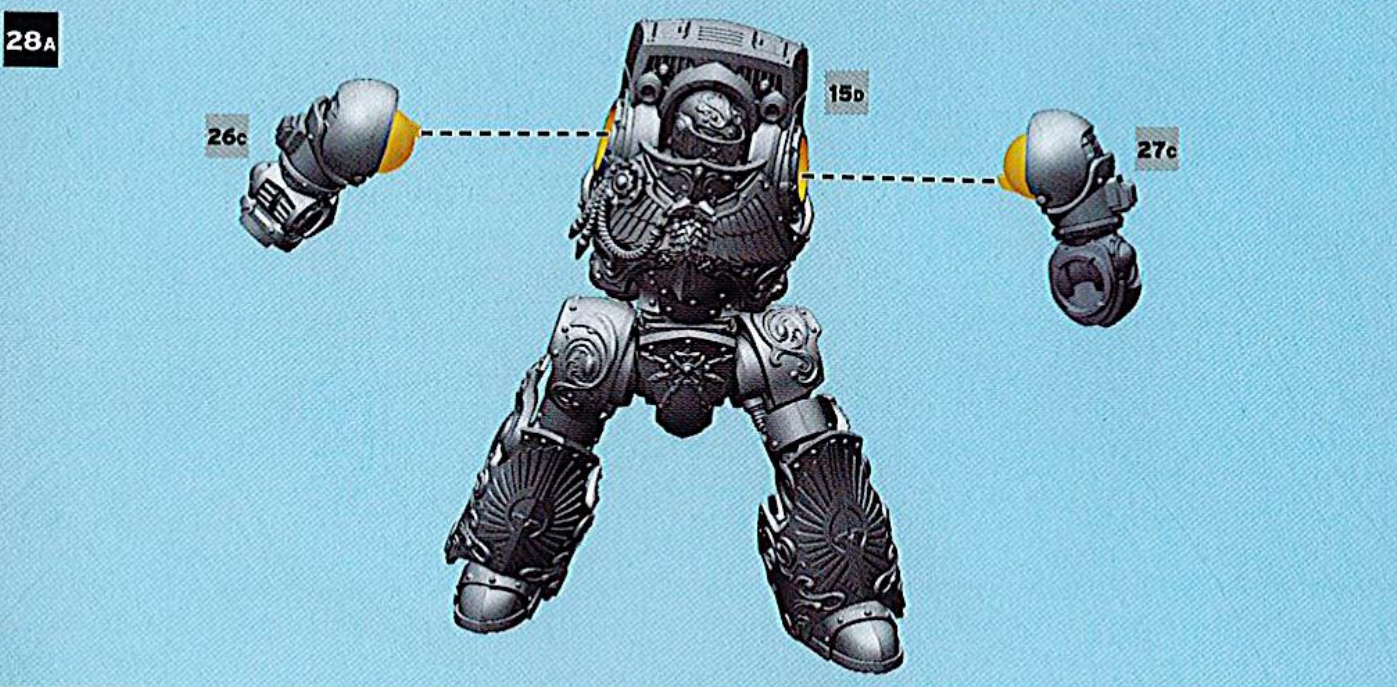
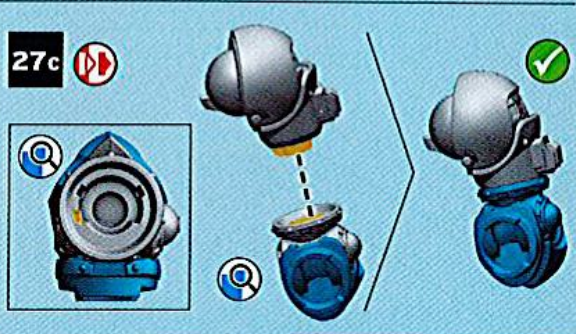
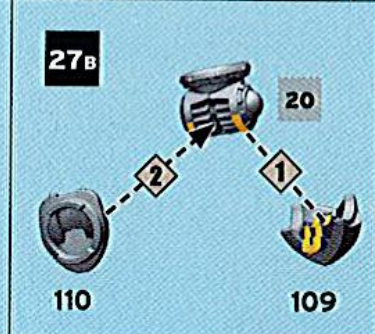
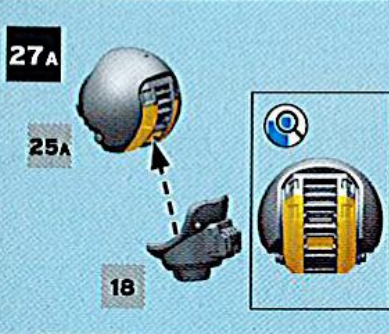
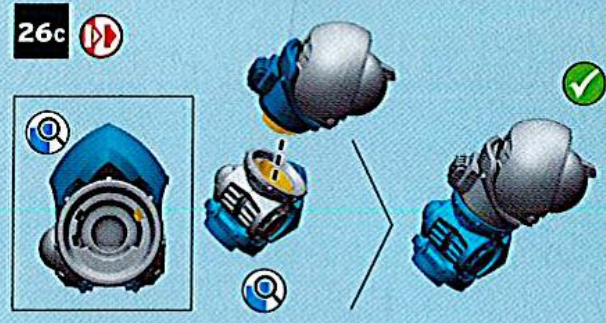
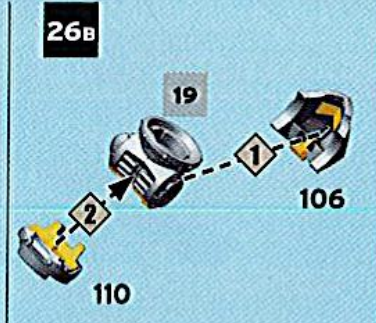
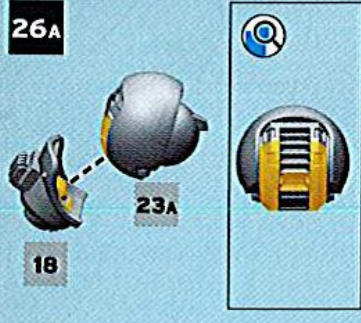

28c

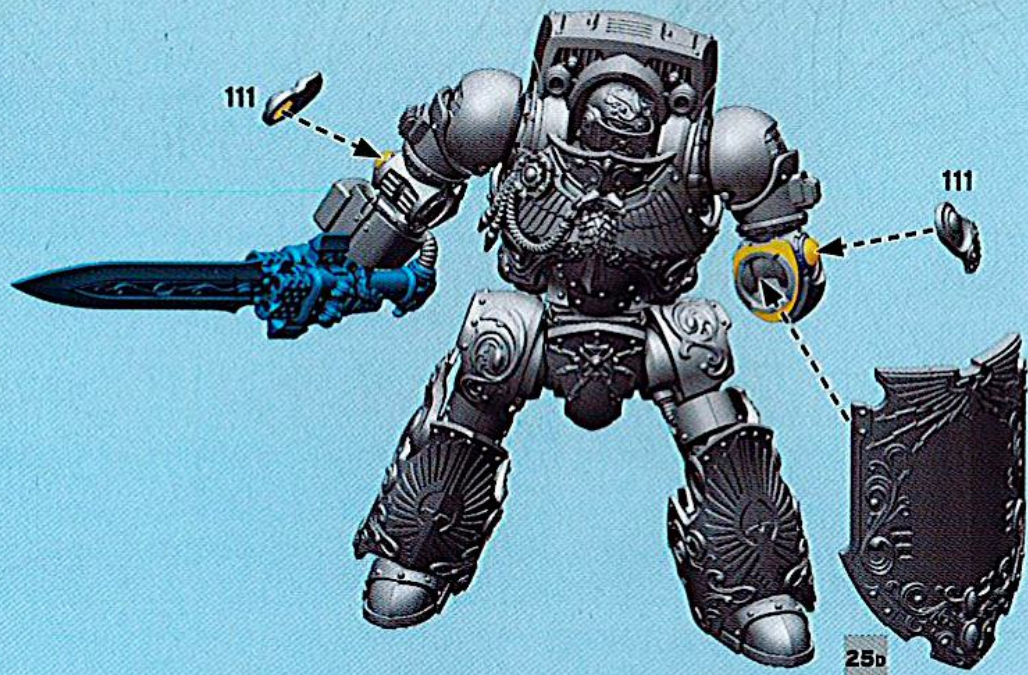

28d

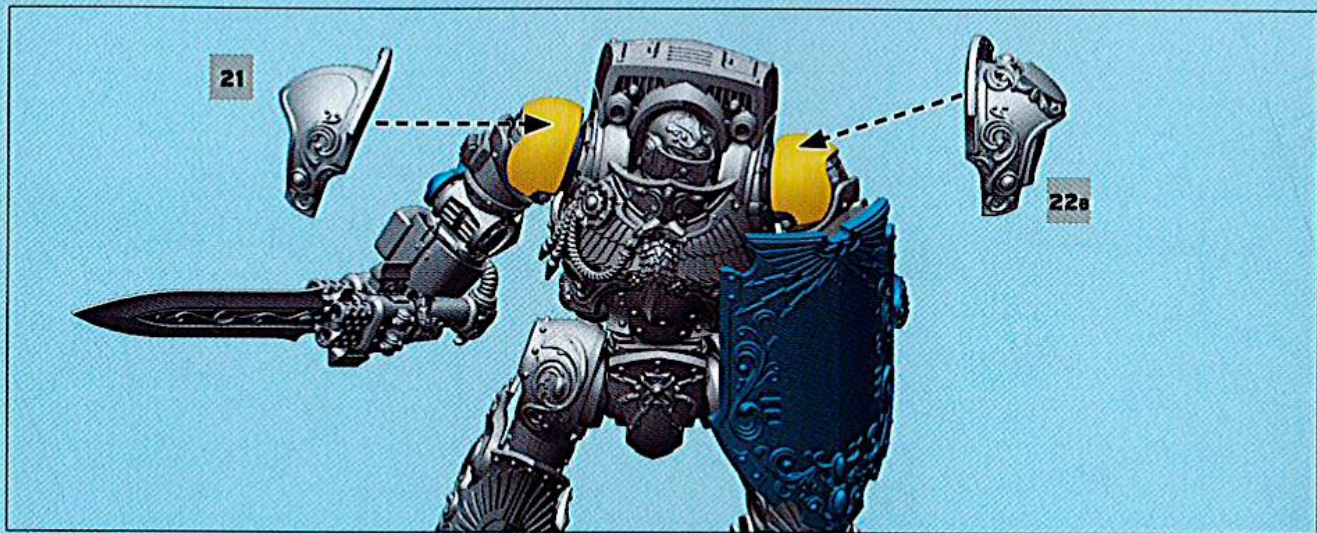

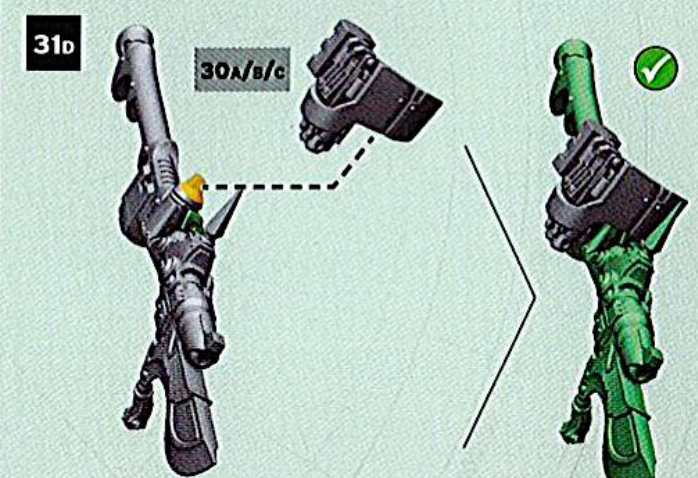
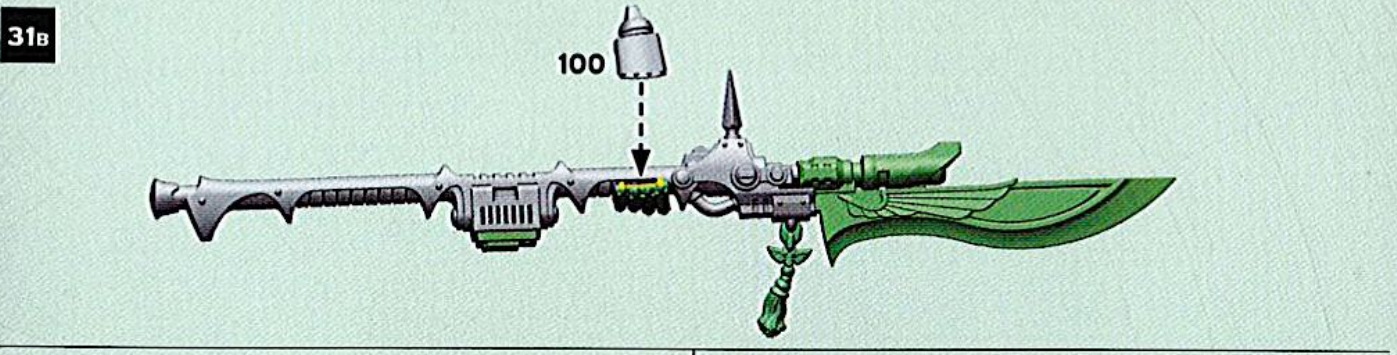
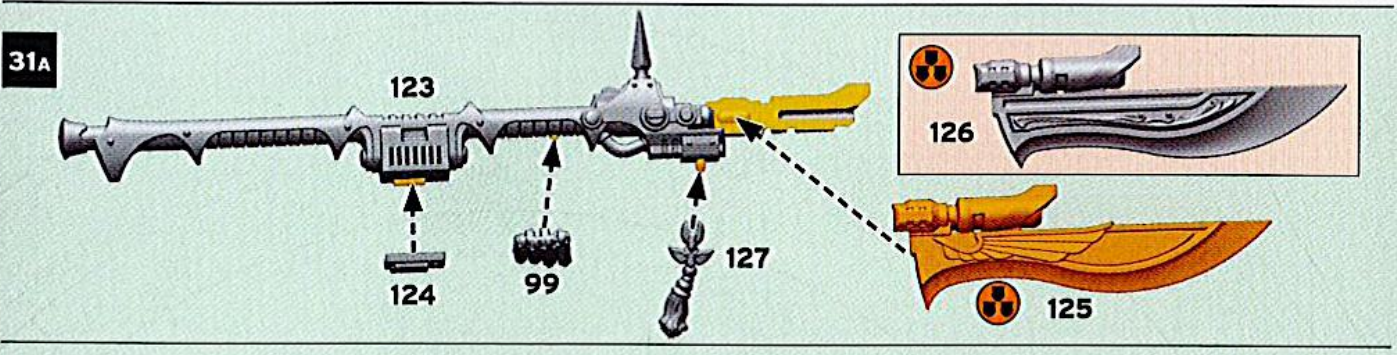
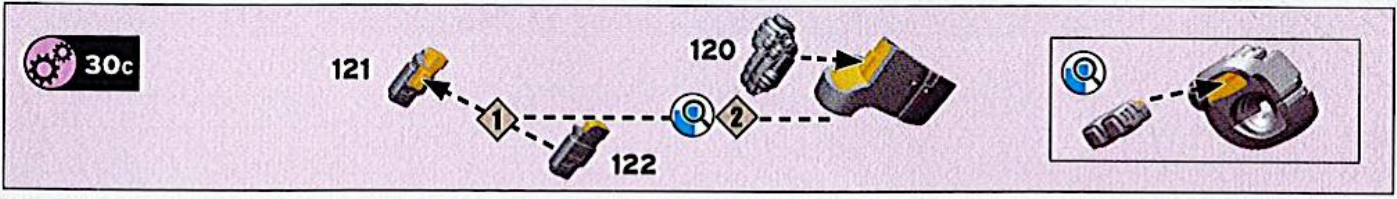
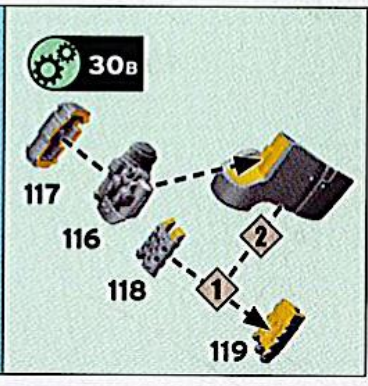
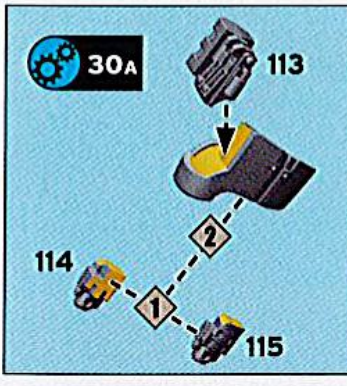
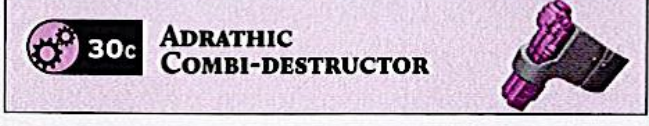
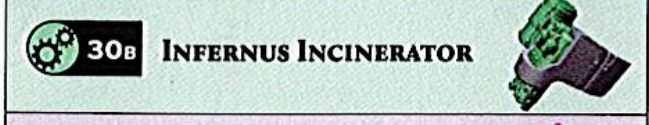
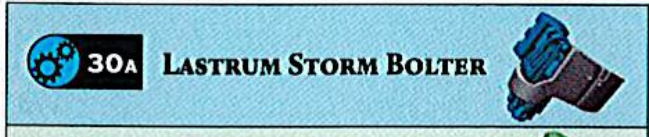
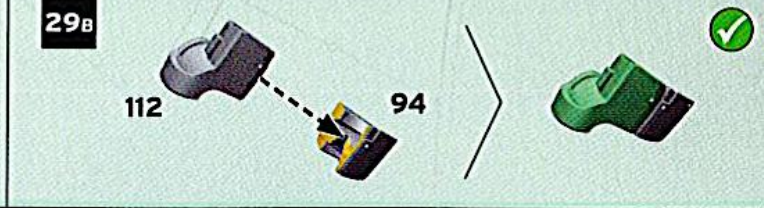
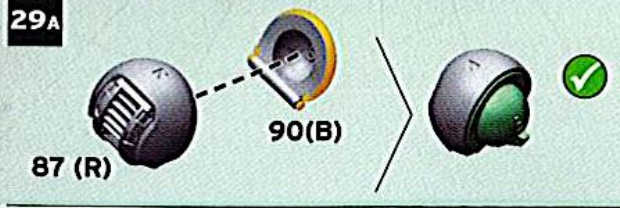

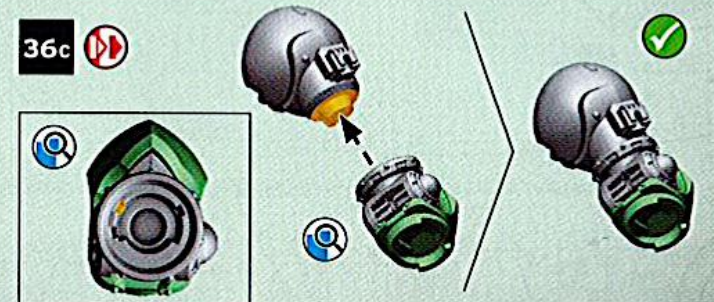
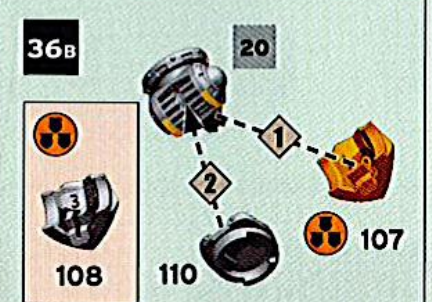
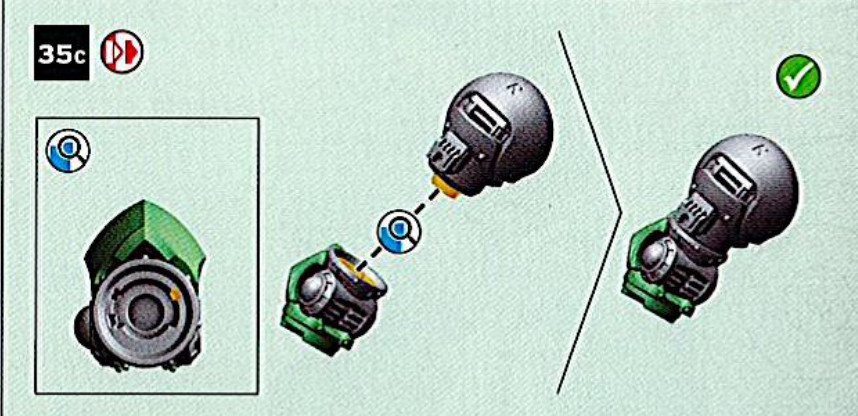
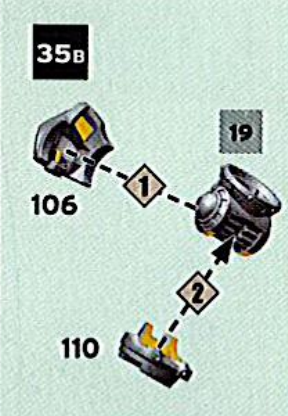
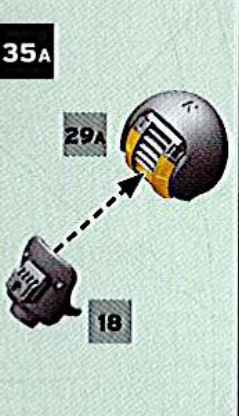
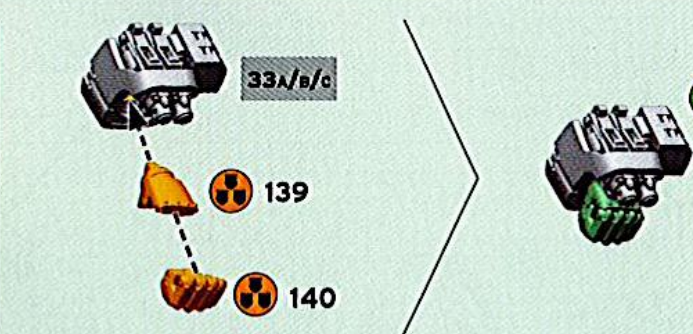
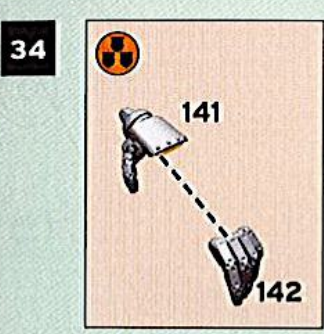
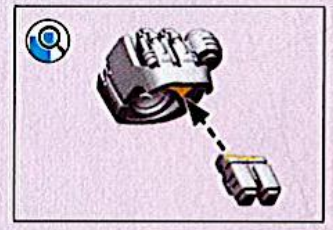
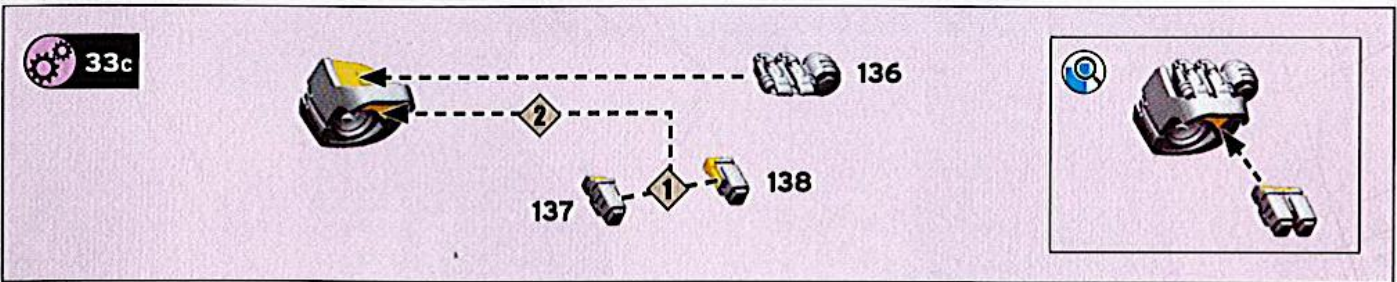
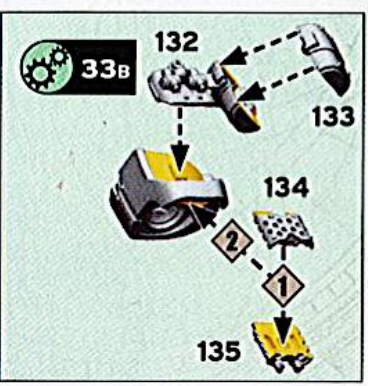
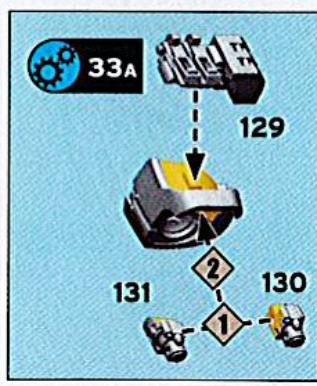
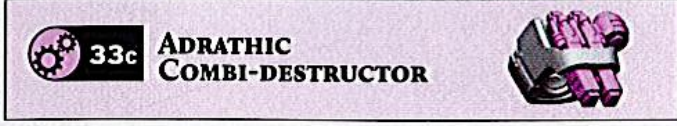
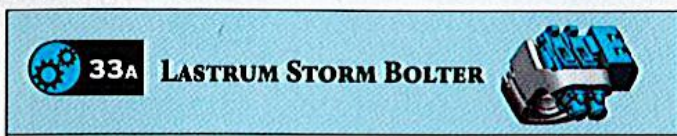
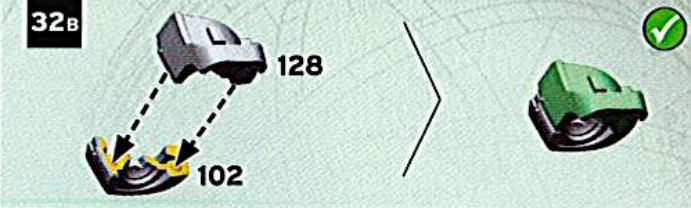
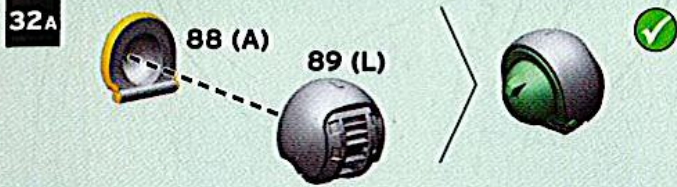

37A

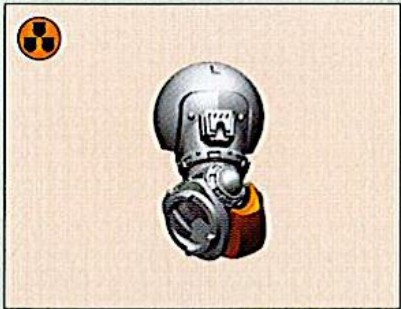

37B

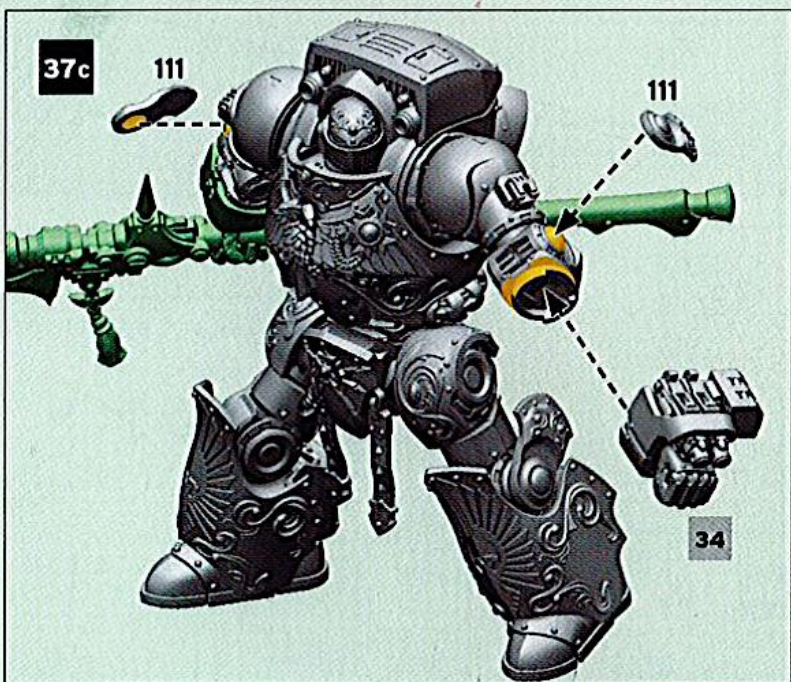

37d

